

SINAMICS G110D

Inverter

Operating Instructions · June 2010



SINAMICS

SIEMENS

SIEMENS

SINAMICS

SINAMICS G110D

Operating Instructions

<u>Warnings and cautions</u>	1
<u>Introduction</u>	2
<u>Description</u>	3
<u>Connection</u>	4
<u>Commissioning</u>	5
<u>Functions</u>	6
<u>Service and maintenance</u>	7
<u>Messages and fault codes</u>	8
<u>Technical data</u>	9
<u>Appendix A</u>	A

Edition 06/2010, Firmware version 3.4

Legal information

Warning notice system

This manual contains notices you have to observe in order to ensure your personal safety, as well as to prevent damage to property. The notices referring to your personal safety are highlighted in the manual by a safety alert symbol, notices referring only to property damage have no safety alert symbol. These notices shown below are graded according to the degree of danger.

 DANGER
indicates that death or severe personal injury will result if proper precautions are not taken.

 WARNING
indicates that death or severe personal injury may result if proper precautions are not taken.

 CAUTION
with a safety alert symbol, indicates that minor personal injury can result if proper precautions are not taken.

CAUTION
without a safety alert symbol, indicates that property damage can result if proper precautions are not taken.

NOTICE
indicates that an unintended result or situation can occur if the corresponding information is not taken into account.

If more than one degree of danger is present, the warning notice representing the highest degree of danger will be used. A notice warning of injury to persons with a safety alert symbol may also include a warning relating to property damage.

Qualified Personnel

The product/system described in this documentation may be operated only by **personnel qualified** for the specific task in accordance with the relevant documentation for the specific task, in particular its warning notices and safety instructions. Qualified personnel are those who, based on their training and experience, are capable of identifying risks and avoiding potential hazards when working with these products/systems.

Proper use of Siemens products

Note the following:

 WARNING
Siemens products may only be used for the applications described in the catalog and in the relevant technical documentation. If products and components from other manufacturers are used, these must be recommended or approved by Siemens. Proper transport, storage, installation, assembly, commissioning, operation and maintenance are required to ensure that the products operate safely and without any problems. The permissible ambient conditions must be adhered to. The information in the relevant documentation must be observed.

Trademarks

All names identified by ® are registered trademarks of the Siemens AG. The remaining trademarks in this publication may be trademarks whose use by third parties for their own purposes could violate the rights of the owner.

Disclaimer of Liability

We have reviewed the contents of this publication to ensure consistency with the hardware and software described. Since variance cannot be precluded entirely, we cannot guarantee full consistency. However, the information in this publication is reviewed regularly and any necessary corrections are included in subsequent editions.

Table of contents

1	Warnings and cautions	15
1.1	Warning and Cautions	15
2	Introduction	21
2.1	About this manual	21
2.2	Adapting the Inverter to the application	22
2.2.1	General basics	22
2.2.2	Parameter	22
2.2.3	Parameters with follow-on parameterization.....	23
2.2.4	Frequently required parameters.....	24
2.3	Extended adaptation of parameters.....	26
2.3.1	BICO technology: basic principles	26
2.3.2	BICO technology: example	28
3	Description	31
3.1	Overview of SINAMICS G110D Inverters	31
3.2	Components of the Inverter system.....	32
4	Connection	37
4.1	Procedure for installing the Inverter.....	37
4.2	General layout of SINAMICS G110D.....	38
4.3	Removal of CU area cover and braking resistor connection hatch	39
4.4	Drill pattern for the SINAMICS G110D	40
4.5	Mounting orientation	41
4.6	Ambient operating conditions.....	42
4.7	SINAMICS G110D Specifications	43
4.8	Cables and connections.....	44
4.9	Configuring the AS-i slave	50
4.10	Using the AS-i Programmer	55
5	Commissioning	59
5.1	Typical commissioning scenarios	59
5.2	Restoring the factory settings	60
5.3	Preparing for commissioning	61
5.4	Prerequisites of using the factory settings	64
5.5	Factory settings for the Inverter	64
5.6	Commissioning with STARTER.....	66
5.7	Commissioning with the IOP.....	76

5.8	Example application	81
5.9	Backup data and storage	85
5.9.1	Saving and transferring data using the IOP	85
5.9.2	Saving and transferring data using the MMC	86
6	Functions	89
6.1	Overview of Inverter functions	89
6.2	Inverter Control	91
6.2.1	Frequency inverter control using digital inputs (two/three-wire control)	91
6.2.2	Two-wire control, method 1	94
6.2.3	Two-wire control, method 2	95
6.2.4	Two-wire control, method 3	96
6.2.5	Three-wire control, method 1	97
6.2.6	Three-wire control, method 2	99
6.3	Command sources	100
6.3.1	Selecting command sources	100
6.3.2	Assigning functions to digital inputs	101
6.3.3	Controlling the motor using the fieldbus	102
6.4	Setpoint sources	102
6.4.1	Selecting the setpoint source [P1000]	102
6.4.2	Frequency setpoint using analog input [P1000=2]	103
6.4.3	Using a motorized potentiometer as a setpoint source	103
6.4.4	Using fixed frequencies as a setpoint source	104
6.4.5	Running the motor in jog mode (JOG function)	105
6.4.6	Specifying the motor speed via the fieldbus	106
6.5	Changing over the command data sets (manual, automatic)	107
6.6	Setpoint preparation	109
6.6.1	Overview of setpoint preparation	109
6.6.2	Minimum frequency and maximum frequency	109
6.6.3	Parameterizing the ramp-function generator	110
6.7	Motor control	111
6.7.1	V/f control with linear characteristics	111
6.7.2	V/f control with parabolic characteristic	113
6.7.3	Typical applications for V/f control	113
6.7.4	Additional characteristics of the V/f control	113
6.8	Protection functions	114
6.8.1	Protective functions of the frequency inverter	114
6.8.2	Overtemperature protection for the Inverter	115
6.8.3	Overcurrent protection	117
6.8.4	Limiting the maximum DC link voltage	119
6.8.5	Load torque monitoring (system protection)	120
6.9	Technological functions	121
6.9.1	Technological functions	121
6.9.2	Braking functions	122
6.9.2.1	Braking functions of the Inverter	122
6.9.2.2	DC braking	123
6.9.2.3	Dynamic braking	125
6.9.2.4	Parameterizing a motor holding brake	127
6.9.3	Automatic restart and flying restart	131
6.9.3.1	Automatic restart	131
6.9.3.2	Flying restart	135

6.9.4	PID technology controller	137
6.9.5	Logical functions using function blocks	138
6.9.6	Changing over drive data sets	139
6.10	Quick Stop function	141
6.11	Operation in fieldbus systems	145
6.11.1	Communication via AS-i Network	145
6.11.1.1	Overview	145
6.11.1.2	Connecting the Inverter to AS-i network	147
6.11.1.3	Example: configuring the Inverter on the AS-i network	148
6.11.1.4	AS-i Profile	155
6.11.1.5	Step 7 example conveyor program	172
6.11.1.6	Example application	178
7	Service and maintenance	183
7.1	Behaviour of the Inverter when replacing components	183
7.2	Replacing the Inverter	184
7.3	Local/remote switch cover	185
7.4	Repair switch	186
8	Messages and fault codes	189
8.1	Fault codes	189
8.2	LED States	190
9	Technical data	193
9.1	Technical data of the SINAMICS G110D	193
9.2	Pulse frequency and current reduction	195
A	Appendix A	197
A.1	Electromagnetic compatibility	197
A.1.1	Classification of EMC categories	197
A.1.2	EMC performance	199
A.2	Standards	201
	Index	203

Tables

Table 2- 1	This is how you filter the parameter list to keep the number of displayed parameters to a minimum.....	24
Table 2- 2	How to switch to commissioning mode or restore the factory setting.....	24
Table 2- 3	How to determine the firmware version of the Control Unit.....	24
Table 2- 4	This is how you reset the parameters to the factory setting.....	24
Table 2- 5	This is how you select the command source of the control signals (ON/OFF, reversing) of the inverter.....	24
Table 2- 6	This is how you select the setpoint source for the frequency.....	25
Table 2- 7	This is how you parameterize the up and down ramps.....	25
Table 2- 8	This is how you optimize the starting behavior of the V/f control for a high break loose torque and overload.....	25
Table 2- 9	Binector symbols.....	27
Table 2- 10	Connector symbols.....	27
Table 2- 11	Connector and binector output symbols.....	28
Table 2- 12	Parameterizing an interlock.....	29
Table 3- 1	SINAMICS G110D Braking resistors.....	36
Table 4- 1	Rated Output, Input and Fuses.....	43
Table 4- 2	Tools.....	47
Table 4- 3	Control Unit connectors.....	47
Table 4- 4	Mains supply connector.....	47
Table 4- 5	Motor connector.....	48
Table 4- 6	Temperature sensor and EM brake.....	48
Table 4- 7	Mains supply and motor output specifications.....	48
Table 4- 8	Digital input specifications.....	49
Table 4- 9	Analog input specifications.....	49
Table 4- 10	AS-i connector specifications.....	49
Table 4- 11	Equipment for installation of SINAMICS G110D (AS-i).....	51
Table 5- 1	Command and setpoint sources.....	64
Table 5- 2	Factory setting of additional important parameters.....	65
Table 5- 3	Function of the IOP controls.....	78
Table 5- 4	Handheld device order information.....	79
Table 5- 5	Conveyor application parameters.....	83
Table 6- 1	Comparison of the methods for two-wire motor control.....	92
Table 6- 2	Comparison of the methods for three-wire motor control.....	93
Table 6- 3	Function table.....	95

Table 6- 4	Parameterizing the function	95
Table 6- 5	Function table.....	96
Table 6- 6	Parameterizing the function	96
Table 6- 7	Function table.....	97
Table 6- 8	Parameterizing the function	97
Table 6- 9	Function table.....	98
Table 6- 10	Parameterizing the function	98
Table 6- 11	Function table.....	99
Table 6- 12	Parameterizing the function	100
Table 6- 13	Parameters, to select the source for the inverter control commands	100
Table 6- 14	Factory setting of the digital inputs	101
Table 6- 15	Changing the digital input settings.....	101
Table 6- 16	Settings to select the possible frequency setpoint sources	102
Table 6- 17	Set and parameterize the analog input for use as setpoint source	103
Table 6- 18	Example: Implementing the motorized potentiometer using the Operator Panel keys.....	103
Table 6- 19	Example: Implementing a motorized potentiometer using digital inputs	104
Table 6- 20	Parameters to directly select frequencies.....	105
Table 6- 21	Example: Selecting 2 fixed frequencies using digital input 2 and digital input 3	105
Table 6- 22	Example: Enabling the jog mode	106
Table 6- 23	Parameter to assign the JOG function to another button	106
Table 6- 24	Command data set changeover using parameters P0810 and P0811.....	108
Table 6- 25	Parameters for switching the command data sets:.....	108
Table 6- 26	Parameters for minimum and maximum frequency	110
Table 6- 27	Parameters for ramp-up time and ramp-down time	110
Table 6- 28	Rounding parameters	111
Table 6- 29	Setting the control type	111
Table 6- 30	Optimizing the starting characteristics for a linear characteristic.....	112
Table 6- 31	Setting the control type	113
Table 6- 32	Further V/f control methods (P1300)	114
Table 6- 33	Parameters to sense the temperature using a temperature sensor	117
Table 6- 34	I_{max} controller parameters.....	118
Table 6- 35	V_{DCmax} controller parameters.....	119
Table 6- 36	Parameterizing the monitoring functions	120
Table 6- 37	Braking methods depending on the application.....	122
Table 6- 38	Parameters to enable and set DC braking.....	124
Table 6- 39	Parameters to enable and set dynamic braking	127

Table 6- 40	Control logic parameters of the motor holding brake	130
Table 6- 41	Parameter to force open a motor holding brake	131
Table 6- 42	Parameterizing the automatic restart	133
Table 6- 43	Principle of operation of the automatic restart	133
Table 6- 44	Overview of the automatic restart characteristics	135
Table 6- 45	Main function parameters.....	136
Table 6- 46	Overview: the "flying restart" function	136
Table 6- 47	Additional commissioning parameters	137
Table 6- 48	Technology controller parameters	138
Table 6- 49	Parameters for using the free function blocks.....	139
Table 6- 50	Parameters for switching the drive data sets:.....	141
Table 6- 51	Quick Stop parameters	143
Table 6- 52	ASI connector specifications	147
Table 6- 53	AS-i single slave identities	155
Table 6- 54	Selection of slave mode (P2022)	155
Table 6- 55	AS-i dual slave identities	157
Table 6- 56	Summary of parameter P2021 settings	159
Table 6- 57	ID1 Code modification (P2023).....	159
Table 6- 58	Default input process image (slave to master) - Dual slave mode	160
Table 6- 59	Default output process image (master to slave) - Dual slave mode	161
Table 6- 60	Default input process image (slave to master) - Single slave mode.....	161
Table 6- 61	Default output process image (master to slave) - Single slave mode	162
Table 6- 62	Request IDs from master to slave.....	163
Table 6- 63	Response IDs from slave to master	163
Table 6- 64	PKW error codes	164
Table 6- 65	IND parameter index	165
Table 6- 66	CCT2 commands	166
Table 6- 67	Standard error codes	167
Table 6- 68	Conveyor application parameters	180
Table 7- 1	Switch cover function description.....	186
Table 8- 1	Fault codes description	189
Table 8- 2	SINAMICS G110D LED states.....	191
Table 9- 1	Weight of SINAMICS G110 Inverters with repair switch.....	194
Table 9- 2	Weight of SINAMICS G110 Inverters without repair switch.....	194
Table 9- 3	Current reduction depending on pulse frequency.....	195
Table A- 1	Compliance Table	199

Table A- 2	Conducted & Radiated Emissions	199
Table A- 3	Harmonic Currents	200
Table A- 4	EMC Immunity.....	200

Figures

Figure 2-1	Example: Pre-assigned signal interconnection for digital input 0 of a non-bus-capable Control Unit	26
Figure 2-2	Example: MOP function (motorized potentiometer)	26
Figure 2-3	Example: Signal interconnection for interlock	29
Figure 2-4	Default parameterization	29
Figure 2-5	BICO parameterization	29
Figure 2-6	Interconnection after insertion of two functions	29
Figure 3-1	SINAMICS G110D FSA	32
Figure 3-2	SINAMICS G110D FSB	33
Figure 3-3	SINAMICS G110D FSC	33
Figure 4-1	SINAMICS G110D Inverter	38
Figure 4-2	Removal of CU area cover and braking resistor connection hatch	39
Figure 4-3	Drill pattern SINAMICS G110D	40
Figure 4-4	Correct Inverter orientation	41
Figure 4-5	Power derating for temperature	42
Figure 4-6	Derating for altitude	42
Figure 4-7	SINAMICS G110D block diagram	46
Figure 4-8	Example AS-i configuration	52
Figure 4-9	Addressing the ASi slave	54
Figure 5-1	Communications interfaces	60
Figure 5-2	Rating plate data as parameters	62
Figure 5-3	Create new project dialog	67
Figure 5-4	Insert drive	67
Figure 5-5	Select drive dialog	68
Figure 5-6	Configure drive unit	68
Figure 5-7	Select power unit dialog	69
Figure 5-8	Summary dialog	69
Figure 5-9	Select control method dialog	70
Figure 5-10	Select command and setpoint source dialog	70
Figure 5-11	Select drive settings dialog	71
Figure 5-12	Select motor type dialog	71
Figure 5-13	Motor data dialog	72
Figure 5-14	Motor identification dialog	72
Figure 5-15	Important parameters dialog	73
Figure 5-16	Calculate motor data dialog	73



Figure 5-17	Configuration summary	74
Figure 5-18	Control panel activation	74
Figure 5-19	STARTER control panel.....	75
Figure 5-20	Expert list	75
Figure 5-21	Layout of IOP	77
Figure 5-22	IOP Handheld Kit	79
Figure 5-23	Example conveyor application	82
Figure 5-24	Example S7 script.....	83
Figure 5-25	Example S7 ladder logic	84
Figure 6-1	Overview of Inverter functions	89
Figure 6-2	Two-wire control using digital inputs, method 1.....	94
Figure 6-3	Two-wire control using digital inputs, method 2.....	95
Figure 6-4	Two-wire control using digital inputs, method 3.....	96
Figure 6-5	Three-wire control using digital inputs, method 1	97
Figure 6-6	Three-wire control using digital inputs, method 2	99
Figure 6-7	CDS switchover in the inverter.....	107
Figure 6-8	Setpoint calculation in the inverter	109
Figure 6-9	DC braking after an OFF1 or OFF3 command	123
Figure 6-10	DC braking using external selection	125
Figure 6-11	Braking chopper in the Inverter.....	126
Figure 6-12	Function diagram of the motor holding brake control after an OFF1 or OFF3 command	128
Figure 6-13	Function diagram, motor holding brake after an OFF2 command.....	129
Figure 6-14	Example: technology controller as a level controller.....	138
Figure 6-15	Drive Data Sets switchover in Inverter.....	140
Figure 6-16	Conveyor example 1	142
Figure 6-17	Conveyor example 2	142
Figure 6-18	Conveyor example 3	142
Figure 6-19	Positive edge triggered signals reactions	144
Figure 6-20	High level triggered signals reactions	144
Figure 6-21	Keypad Quick Stop override	144
Figure 6-22	AS-i network structure.....	145
Figure 6-23	AS-i communications using Manchester coding	146
Figure 6-24	Using the CP343-2 Master with the S7-300	149
Figure 6-25	AS-i master - set button	150
Figure 6-26	Setting the address on the Inverter.....	151
Figure 6-27	Properties dialog CP343-2 - addresses.....	152

Figure 6-28	Properties dialog CP343-2 - operating parameters	152
Figure 6-29	Properties dialog CP343-2 - slave configuration	153
Figure 6-30	Configuring an individual slave	154
Figure 6-31	Configuring standard AS-i slave	154
Figure 6-32	Single Slave Internal data flow.....	156
Figure 6-33	Dual slave internal data flow	157
Figure 6-34	PKW component structure	162
Figure 6-35	PKE component structure	163
Figure 6-36	IND component structure	165
Figure 6-37	PWE component structure	166
Figure 6-38	Cyclic data transfer	167
Figure 6-39	Cyclic data output.....	167
Figure 6-40	Cyclic data input.....	168
Figure 6-41	Standard ID read request and response.....	168
Figure 6-42	Standard diagnostic request and response	168
Figure 6-43	Unrecognised standard acyclic request and response	168
Figure 6-44	Parameter read request and response	170
Figure 6-45	Parameter write request and response.....	171
Figure 6-46	Parameter exchange request and response.....	172
Figure 6-47	Example conveyor application script - main program	173
Figure 6-48	Example conveyor application script - control of several conveyor belts	175
Figure 6-49	Example conveyor application script - controlling a conveyor belt	175
Figure 6-50	Example conveyor script - control a conveyor belt without block parameters	176
Figure 6-51	Example conveyor application script - parts counter with monitor.....	177
Figure 6-52	Example conveyor script - parts counter and monitoring without block parameters	178
Figure 6-53	Example conveyor application	179
Figure 6-54	Example S7 script	180
Figure 6-55	Example S7 ladder logic	181
Figure 7-1	Local/remote switch cover layout.....	185
Figure 7-2	Repair switch.....	187
Figure 8-1	SINAMICS G110D LEDs.....	190

Warnings and cautions

1.1 Warning and Cautions

General

 WARNING
<p>This equipment contains dangerous voltages and controls potentially dangerous rotating mechanical parts. Non-compliance with the warnings or failure to follow the instructions contained in this manual can result in loss of life, severe personal injury or serious damage to property.</p> <p>Protection in case of direct contact by means of SELV / PELV is only permissible in areas with equipotential bonding and in dry indoor rooms. If these conditions are not fulfilled, other protective measures against electric shock must be applied e.g. protective insulation.</p> <p>Only suitably qualified personnel should work on this equipment, and only after becoming familiar with all safety notices, installation, operation and maintenance procedures contained in this manual. The successful and safe operation of this equipment is dependent upon its proper handling, installation, operation and maintenance.</p> <p>As the earth leakage for this product can be greater than 3.5 mA a.c., a fixed earth connection is required and the minimum size of the protective earth conductor shall comply with the local safety regulations for high leakage current equipment. In this case a permanent, immovable connection is required and the following measures must also be taken:</p> <ul style="list-style-type: none">• Minimum PE conductor cross-section of 10 mm².• Laying a second PE conductor using separate terminals, with a cross-section that, in itself, fulfills all the requirements for PE conductors.• Self-actuating switch-off of the power supply if the PE conductor is interrupted.• Insertion of a two-winding transformer into the power supply. <p>Due to the high inrush currents in the earth conductor, this product is not compatible with an RCD (also referred to as an ELCB or RCCB).</p> 
<p>The power supply, DC and motor terminals, the brake and thermistor cables can carry dangerous voltages even if the inverter is inoperative. Wait at least five minutes to allow the unit to discharge after switching off the line supply before carrying out any installation work.</p> <p>It is strictly prohibited for any mains disconnection to be performed on the motor-side of the system; any disconnection of the mains must be performed on the mains-side of the Inverter.</p> <p>When connecting the line supply to the Inverter, make sure that the terminal case of the motor is closed.</p>



During operation and for a short time after switching-off the Inverter, the surfaces of the Inverter can reach a high temperature.

This equipment is capable of providing internal motor overload protection according to UL508C. Refer to P0610 and P0335, i²t is ON by default.

When changing from the ON to OFF-state of an operation if an LED or other similar display is not lit or active; this does not indicate that the unit is switched-off or powered-down.

The inverter must always be grounded.

Isolate the line supply before making or changing connections to the unit.

Use of mobile radio devices (e.g. telephones, walkie-talkies) with a transmission power > 1 W in the immediate vicinity of the devices (< 1.8 m) can interfere with the functioning of the equipment.

Do not disconnect power connections when the Inverter and motor are under load.

Ensure that the inverter is configured for the correct supply voltage. The inverter must not be connected to a higher voltage supply.



Static discharges on surfaces or interfaces that are not generally accessible (e.g. terminal or connector pins) can cause malfunctions or defects. Therefore, when working with inverters or inverter components, ESD protective measures should be observed.

Take particular notice of the general and regional installation and safety regulations regarding work on dangerous voltage installations (e.g. EN 50178) as well as the relevant regulations regarding the correct use of tools and personal protective equipment (PPE).

 **CAUTION**

Children and the general public must be prevented from accessing or approaching the equipment!

This equipment may only be used for the purpose specified by the manufacturer. Unauthorized modifications and the use of spare parts and accessories that are not sold or recommended by the manufacturer of the equipment can cause fires, electric shocks and injuries.

NOTICE

Keep this manual within easy reach of the equipment and make it available to all users.

Whenever measuring or testing has to be performed on live equipment, the regulations of Safety Code BGV A2 must be observed, in particular § 8 "Permissible Deviations when Working on Live Parts". Suitable electronic tools should be used.

Before installing and commissioning, please read these safety instructions and warnings carefully and all the warning labels attached to the equipment. Make sure that the warning labels are kept in a legible condition and replace missing or damaged labels.

Transport and storage

 WARNING
Correct transport, storage as well as careful operation and maintenance are essential for the proper and safe operation of the equipment.

 CAUTION
Protect the equipment against physical shocks and vibration during transport and storage. It is important that the equipment is protected from water (rainfall) and excessive temperatures.

Commissioning

 WARNING
Working on the equipment by unqualified personnel or failure to comply with warnings can result in severe personal injury or serious damage to material. Only suitably qualified personnel trained in the setup, installation, commissioning and operation of the product should carry out work on the equipment.

 CAUTION
Cable connection The control cables must be laid separately from the power cables. Carry out the connections as shown in the installation section in this manual, to prevent inductive and capacitive interference from affecting the correct function of the system.

Operation

 WARNING
<p>The Inverter operate at high voltages.</p> <p>When operating electrical devices, it is impossible to avoid applying hazardous voltages to certain parts of the equipment.</p> <p>Emergency Stop facilities according to EN 60204, IEC 204 (VDE 0113) must remain operative in all operating modes of the control equipment. Any disengagement of the Emergency Stop facility must not lead to an uncontrolled or an undefined restart of the equipment.</p> <p>Certain parameter settings may cause the Inverter to restart automatically after an input power failure, for example, the automatic restart function.</p> <p>Wherever faults occurring in the control equipment can lead to substantial material damage or even grievous bodily injury (that is, potentially dangerous faults), additional external precautions must be taken or facilities provided to ensure or enforce safe operation, even when a fault occurs (e.g. independent limit switches, mechanical interlocks, etc.).</p> <p>Motor parameters must be accurately configured for motor overload protection to operate correctly.</p> <p>This equipment is capable of providing internal motor overload protection according to UL508C.</p> <p>Only Inverters with fail-safe functions can be used as an "Emergency Stop Mechanism" (see EN 60204, section 9.2.5.4).</p>

Repair

 WARNING
<p>Repairs on equipment may only be carried out by Siemens Service, by repair centers authorized by Siemens or by authorized personnel who are thoroughly acquainted with all the warnings and operating procedures contained in this manual.</p> <p>Any defective parts or components must be replaced using parts contained in the relevant spare parts list.</p> <p>Disconnect the power supply before opening the equipment for access.</p>

Dismantling and disposal

CAUTION
<p>The packaging of the Inverter is re-usable. Retain the packaging for future use.</p> <p>Easy-to-release screw and snap connectors allow you to break the unit down into its component parts. You can recycle these component parts, dispose of them in accordance with local requirements or return them to the manufacturer.</p>

Introduction

2.1 About this manual

Who requires the operating instructions and why?

These operating instructions primarily address fitters, commissioning engineers and machine operators. The operating instructions describe the devices and device components and enable the target groups being addressed to install, connect-up, parameterize, and commission the inverters safely and in the correct manner.

What is described in the operating instructions?

These operating instructions provide a summary of all of the information required to operate the inverter under normal, safe conditions.

The information provided in the operating instructions has been compiled in such a way that it is sufficient for all standard applications and enables drives to be commissioned as efficiently as possible. Where it appears useful, additional information for entry level personnel has been added.

The operating instructions also contain information about special applications. Since it is assumed that readers already have a sound technical knowledge of how to configure and parameterize these applications, the relevant information is summarized accordingly. This relates, e.g. to operation with fieldbus systems and safety-related applications.

Additional information on SINAMICS G110D

- **As download:** List Manual SINAMICS G110D
Among other things, the List manual includes
 - A detailed description of *all* of the parameters
 - Function diagrams of all of the inverter functions
 - A list of the fault messages and alarms
- **As download:** All of the operating instructions, manuals on SINAMICS G110D
<http://support.automation.siemens.com/WW/view/de/22339653/133300>
- **On DVD:** SD Manual Collection - all manuals on low-voltage motors, geared motors and low-voltage inverters, 5 languages.
 - MLFB: 6SL3298-0CA00-0MG0 (supplied once)
 - MLFB: 6SL3298-0CA10-0MG0 (update service for 1 year; supplied 4 times)
- **As download:** Catalog D 11.1: SINAMICS G110 / G120 Inverter Chassis Units SINAMICS G120D and SINAMICS G110D Distributed Inverters.
http://sd.nes.siemens.de/sales_2003/support/info/catalogues/html_00/index.html#Catalogs_Inverters

The catalog includes ordering data as well as engineering and selection data.

2.2 Adapting the Inverter to the application

2.2.1 General basics

Parameterizable inverters transform standard motors into variable-speed drives

Inverters are parameterized to adapt them to the motor being driven so that this can be optimally operated and protected. This is realized using one of the following operator units:

- Intelligent Operator Panel (IOP) hand-held kit.
- Software (STARTER commissioning tool) that allows the inverter to be parameterized and controlled from a PC.

Inverters are used to improve and expand the starting and speed response of motors.

Many standard applications can function with the default parameters

Although inverters can be parameterized for very specific applications, many standard applications can be configured by means of just a few parameters.

Use the factory settings (where possible)

For basic applications, commissioning can be carried out using just the factory settings.

Use quick commissioning (for simple, standard applications)

In the majority of standard applications, commissioning can be carried out by entering or changing just a few parameters during quick commissioning.

2.2.2 Parameter

Parameter types

There are two types of parameters, adjustable and display parameters.

Adjustable parameters

Adjustable parameters are represented with four digits preceded by the letter "P". You can change the value of these parameters within a defined range.

Example:

P0305 is the parameter for the rated motor current in Amps. This parameter is set during commissioning. You can enter values between 0.01 and 10000.

Display parameters

Display parameters are represented with four digits preceded by the letter "r". You cannot change the value of these parameters.

Example:

r0027 is the parameter for the inverter output current. The inverter measures the current and writes the current value to the parameter. You can display the parameter value, e.g. using an analog output of the inverter.

Change protection for setting parameters

The process of changing parameter values is subject to certain conditions. If an attempt to change a parameter is rejected by the inverter, this can have a number of causes:

1. The inverter operating state does not allow you to change parameters.
For example, certain parameters can only be changed when the inverter is in commissioning mode.
2. In some cases, you may not be able to change certain parameters due to automatic follow-on parameterization.
Example: When P0701 = 1, the ON/OFF1 command is connected to digital input 0. As follow-on parameterization, P0840 (source of the ON/OFF1 command) is assigned value 722.0 (status of digital input 0), which means that P0840 can no longer be changed.
3. Parameter protection via P0927 has been activated.
Example: P0927 = 1101 prevents parameters from being changed from the BOP.

For each parameter, the List Manual specifies whether and which conditions apply for changing the values.

2.2.3**Parameters with follow-on parameterization**

When you change certain parameters, the system may automatically change other parameters accordingly. This makes it much easier to parameterize complex functions.

Example: Parameter P0700 (command source)

Parameter P0700 can be used to switch the command source from the fieldbus to digital inputs. When the value of P0700 is changed from 6 (command source "fieldbus") to 2 (command source "digital inputs"), other parameter values are changed automatically:

- New functions are assigned to the digital inputs (P0701 ... P0704)
- Inverter control is interconnected with the signals from the digital inputs (P0800, P0801, P0840, etc.)

For more information about follow-on parameterization for P0700, see the List Manual.

2.2.4 Frequently required parameters

Parameters that in many cases help

Table 2- 1 This is how you filter the parameter list to keep the number of displayed parameters to a minimum

Parameter	Description
P0003 =	User access level 1: Standard: Allows access to the most frequently used parameters (factory setting) 2: Extended: Extended access, e.g. to inverter I/O functions 3: Expert: To be used by experts
P0004 =	Parameter filter 0: All the parameters are displayed (factory setting). 2: Inverter 3: Motor - data of the motor and output filter are displayed

Table 2- 2 How to switch to commissioning mode or restore the factory setting

Parameter	Description
P0010 =	Commissioning parameters 0: Ready (factory setting) 1: Perform quick commissioning 30: Factory setting - initiate restore factory settings

Table 2- 3 How to determine the firmware version of the Control Unit

Parameter	Description
r0018	The firmware version is displayed:

Table 2- 4 This is how you reset the parameters to the factory setting

Parameter	Description
P0010 = 30	30: Factory setting - initiate restore factory settings
P0970 = 1	1: Resetting - restoring all parameters to the factory setting

Table 2- 5 This is how you select the command source of the control signals (ON/OFF, reversing) of the inverter

Parameter	Description
P0700 =	0: Factory default setting 2: Digital inputs 4: USS on RS 232 6: Fieldbus ; default setting

Table 2- 6 This is how you select the setpoint source for the frequency

Parameters	Description
P1000 =	0: No main setpoint 1: MOP setpoint 3: Fixed frequency (factory default setting) 4: USS at RS 232 6: Fieldbus

Table 2- 7 This is how you parameterize the up and down ramps

Parameters	Description
P1080 = ...	Minimum frequency 0.00 [Hz] factory setting
P1082 = ...	Maximum frequency 50.00 [Hz] factory setting
P1120 = ...	Ramp-up time 10.00 [s]
P1121 = ...	Ramp-down time 10.00 [s]

Table 2- 8 This is how you optimize the starting behavior of the V/f control for a high break loose torque and overload

Parameters	Description
P0003 = 2	Extended access
P1310 = ...	Voltage boost to compensate resistive losses The voltage boost is effective from standstill up to the rated speed. The voltage boost continually decreases with increasing speed. The maximum voltage boost is effective at speed zero and is in V: $V_ConBoost, 100 = \sqrt{3} * P0305 * P0350 * (P1310/100)$
P1311 = ...	Voltage when accelerating The voltage boost is effective from standstill up to the rated speed. The voltage boost is independent of the speed. The voltage boost in V is: $V_AccBoost, 100 = \sqrt{3} * P0305 * P0350 * (P1311/100)$

2.3 Extended adaptation of parameters

2.3.1 BICO technology: basic principles

Functional principle of BICO technology and inverter open-loop control functions

The inverter software offers a range of open-loop control functions, communication functions, as well as various diagnostics and operating functions. These functions are interconnected via internal signal paths and represent the default control structure.

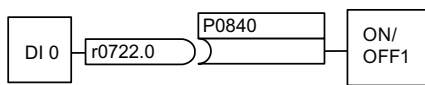

Figure 2-1 Example: Pre-assigned signal interconnection for digital input 0 of a non-bus-capable Control Unit

The functions can be parameterized and interconnected as required. The signal interconnection of the functions is realized, contrary to electric circuitry, not using cables, but in the software. The various functions use a range of inputs, outputs, and parameters.

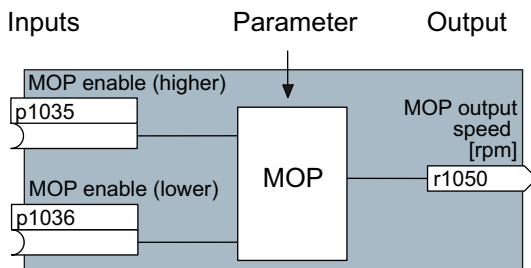

Figure 2-2 Example: MOP function (motorized potentiometer)

Binectors and connectors

Connectors and binectors are elements used to exchange signals between the individual functions. Connectors and binectors can be seen as "storage compartments":

- Connectors are used to store "analog" signals (e.g. speed setpoint)
- Binectors are used to store "digital" signals (e.g. 'MOP raise' command)

Definition of BICO technology

BICO technology describes the type of parameterization that can be used to disconnect all the internal signal interconnections between the functions or establish new connections. This is realized using **Binectors** and **Connectors**. Hence the name **BICO** technology. (Binector Connector Technology)

BICO parameters

You can use the BICO parameters to define the sources of the input signals of a function. This means that using BICO parameters you can define from which connectors and binectors a function reads-in its input signals, thereby enabling you to "interconnect" the functions stored in the devices in accordance with your requirements. Five different BICO parameter types are available:

- Binector inputs: BI
- Connector inputs: CI
- Binector outputs: BO
- Connector outputs: CO
- Binector/connector outputs: CO/BO

Binector/connector outputs (CO/BO) are parameters that combine more than one binector output in a single word (e.g. r0052 CO/BO: status word 1). Each bit in the word represents a digital (binary) signal. This feature reduces the number of parameters and makes it easier to set parameters by means of the serial interface (data transfer).

BICO parameters of type CO, BO, or CO/BO can be used more than once.

BICO symbols, representation, and description

Table 2- 9 Binector symbols



Abbreviation and symbol	Description	Function
BI 	Binector input	
BO 	Binector output	

Table 2- 10 Connector symbols



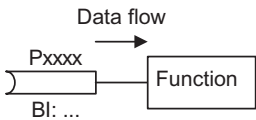

Abbreviation and symbol	Description	Function
CI 	Connector input	
CO 	Connector output	

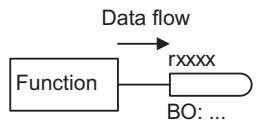
Table 2- 11 Connector and binector output symbols

Abbreviation and symbol	Description	Function
CO/BO 	Binector/connector output	

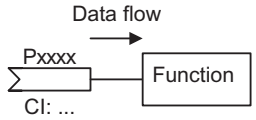
When do you need to use BICO technology?

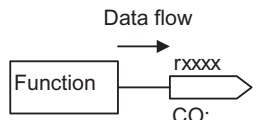
BICO technology allows you to adapt the inverter to a wide range of different requirements. This does not necessarily have to involve highly complex functions.

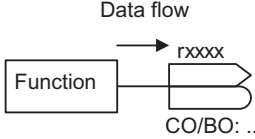
Example 1: Assign a different function to a digital input.

Example 2: Switch over the speed setpoint from the fixed frequency to the analog input.

What precautions should you take when using BICO technology?

Always apply caution when handling internal interconnections. Note which changes you make as you go along since the process of analyzing them later can be quite difficult.

The STARTER commissioning tool offers various screens that make it much easier for you to use BICO technology. The signals that you can interconnect are displayed in plain text, which means that you do not need any prior knowledge of BICO technology.

What sources of information do you need to help you set parameters using BICO technology?

- This manual is sufficient for simple signal interconnections, e.g. assigning a different significance to the to digital inputs.
- The parameter list in the List Manual is sufficient for signal interconnections that go beyond just simple ones.
- You can also refer to the function diagrams in the List Manual for complex signal interconnections.

2.3.2 BICO technology: example

Example: Shifting a basic PLC functionality into the inverter

A conveyor system is to be configured in such a way that it can only start when two signals are present simultaneously. These could be the following signals, for example:

- The light barrier has been activated
- The protective door is closed

The task is realized by inserting free blocks between the digital input 0 and the internal ON command for the motor and interconnecting them.

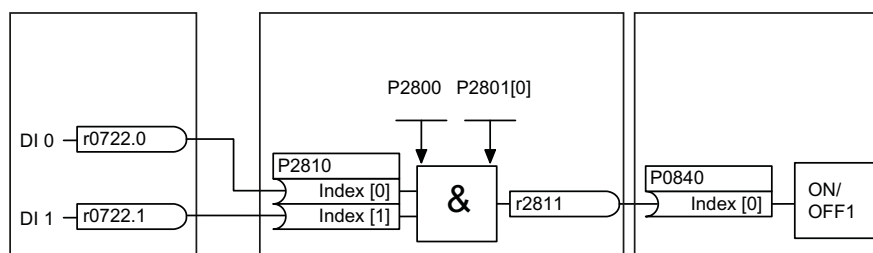

Figure 2-3 Example: Signal interconnection for interlock

Table 2- 12 Parameterizing an interlock

Parameter	Description
P0003 = 3	Enable expert access to parameters
P0700 = 2	Select the command source: Digital inputs
P0701 (e.g.) = 99	Enable/"open" digital input 0 (DI0) for BICO parameterization
P0702 (e.g.) = 99	Enable/"open" digital input 1 (DI1) for BICO parameterization
P2800 = 1	Group enable all freely-programmable function blocks (FFB)
P2801 [In000] = 1	Individual enable of the AND function block
P2810 [In000] = 722.0	Connect the status of DI0 to the 2nd AND
P2810 [In001] = r0722.1	Connect the status of DI1 to the 2nd AND input r0722.1 = Parameter that displays the status of digital input 1.
P0840 = r2811	Connect the AND output to the control command ON/OFF1

Explanations of the example

Open the default signal interconnection for BICO parameterization

The default setting P0701 = 1 indicates the following internal signal interconnection:

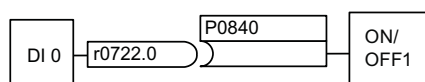

Figure 2-4 Default parameterization

The setting P0701 = 99 means that a pre-assigned signal interconnection is disconnected and therefore the connection opened for BICO parameterization.

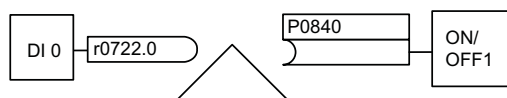

Figure 2-5 BICO parameterization

When P0701 = 99, the binector input of the ON/OFF1 function (P0840) is available for activation by a signal source other than r0722.0 (in this case r2811).

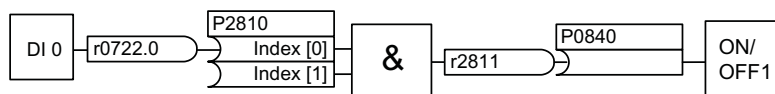

Figure 2-6 Interconnection after insertion of two functions

Principle of connecting functions by means of BICO technology

A connection between two functions comprises a connector/binector and a BICO parameter. Connections are always established with respect to the input of a particular function, which means that the output of an upstream function must always be assigned to the input of a downstream function. The assignment is always made by entering the number of the connector/binector from which the required input signals are read in a BICO parameter.

Description

3.1 Overview of SINAMICS G110D Inverters

SINAMICS G110D Inverters

The SINAMICS G110D has been designed to provide an adaptable solution to conveyor technology applications.

Each SINAMICS G110D Inverter is a complete Power Module and Control Unit in one unique housing which is IP65 rated. The power output range extends from 0.75 kW to 7.5 kW.

The optional STARTER software allows commissioning of the Inverter using a PC with the optional optical cables.

A range of additional, application-specific components are also available, for example, braking resistors.

3.2 Components of the Inverter system

The Inverter system

The Inverter is available in three frame sizes:

Frame size A (FSA)

6SL3511-0PE17-5AM0 - 0.75 kW

6SL3511-1PE17-5AM0 - 0.75 kW with repair switch

6SL3511-0PE21-5AM0 - 1.5 kW

6SL3511-1PE21-5AM0 - 1.5 kW with repair switch

6SL3511-0PE23-0AM0 - 3.0 kW

6SL3511-1PE23-0AM0 - 3.0 kW with repair switch



Figure 3-1 SINAMICS G110D FSA

Frame size B (FSB)

6SL3511-0PE24-0AM0 - 4.0 kW

6SL3511-1PE24-0AM0 - 4.0 kW with repair switch



Figure 3-2 SINAMICS G110D FSB

Frame size C (FSC)

6SL3511-0PE25-5AM0 - 5.5 kW

6SL3511-1PE25-5AM0 - 5.5 kW with repair switch

6SL3511-0PE27-5AM0 - 7.5 kW

6SL3511-1PE27-5AM0 - 7.5 kW with repair switch



Figure 3-3 SINAMICS G110D FSC

The inverter is capable of controlling and monitoring the connected motor in a variety of control modes (which can be selected as required). It supports communication with a local or central controller as well as with monitoring devices.

To enable motors to operate with maximum reliability and flexibility, the Inverter features state-of-the-art IGBT technology with pulse width modulation. The Inverter also features a range of functions designed to offer a high degree of protection for the Inverter and the connected motor.

The Inverter is IP65 rated, which means it is totally protected against dust and protected against low-pressure jets of water from all directions with limited ingress permitted.

Additional components of the Inverter system

In addition to the main Inverter, the following components are available:

Local/remote switch cover

The Local/remote switch cover allows the user to control the Inverter and the connected motor directly from the Inverter. The Local/remote switch cover replaces the standard control unit cover.

Order number: 6SL3555-0PL00-2AA0



IOP Hand-held Kit

The Hand-held Kit supplies the IOP with its own portable power supply which allows the IOP to be used for series commissioning and diagnosis on a number of Inverters.

To connect the IOP Hand-held Kit to all decentralized SINAMICS Inverters, the RS232 optical cable is required - order number: 3RK1922-2BP00.

Order number: 6SL3255-0AA00-4HA0



Memory Card

The memory card can be used for series commissioning of more than one Inverter and for external data backup purposes.

Order number: 6SL3254-0AM00-0AA0.



Memory card holder

The memory card holder allows a memory card to be fitted to the control unit of the Inverter. The memory card holder is located underneath the control unit cover. The memory card holder is capable of reading and writing to both MMC and SD type memory cards.

Order number: 6SL3555-0PM00-0AA0.



Optical cables

The optical cables in conjunction with the STARTER software allows the user to perform a guided, computer-based commissioning of the Inverter. There are two types of optical cables, the details are listed below:

- USB Optical cable - order number: 6SL3555-0PA00-2AA0
- RS232 optical cable - order number: 3RK1922-2BP00.

Adapter Plate

The adapter plate allows the conversion of the M200D motor-starter mounting centres to a SINAMICS G110D configuration and vice versa.

Order number: 6SL3263-1GA20-0GA0.

Braking resistors

There are three different classes of braking resistors available for use with the Inverter.

Table 3- 1 SINAMICS G110D Braking resistors

Order Number	Description	Specification	For use with Inverter
6SL3501-0BE08-6AA0	G110D Braking Resistor	390 ohms / 86 watts average	0.75 kW & 1.5 kW
6SL3501-0BE12-1AA0	G110D Braking Resistor	160 ohms / 210 watts average	3 kW & 4 kW
6SL3501-0BE14-1AA0	G110D Braking Resistor	82 ohms / 410 watts average	5.5 kW & 7.5 kW

Spare parts

The following spare parts are available for the inverter:

- Fan assembly, complete with all necessary fixings.
Order number: 6SL3500-0TF01-0AA0.
- Accessories kit - this contains all the caps and seals used with the Inverter.
Order number: 6SL3500-0TK01-0AA0.

Connection

4.1 Procedure for installing the Inverter

Prerequisites for installing the Inverter

Before you install the Inverter, check that the following preconditions are fulfilled:

- Are the ambient conditions permissible?
- Are the components required for the installation available?
- Are all the necessary tools and spare parts available?
- Have the cables and wires been routed in accordance with the applicable regulations?
- Do the minimum distances from other equipment comply with the specifications?

Installation procedure

- Using the information from the drill pattern, mark the necessary fixing points for the Inverter onto the area on which the Inverter is to be mounted.
- Ensure that the correct orientation of the Inverter is observed.
- Ensure that the ambient operating conditions are observed.
- Ensure that the correct fuse protection is installed.
- Install the memory card holder and memory card if required.
- Construct the necessary cables (in accordance to the information provided).
- Connect the AS-i cable to the AS-i bus.
- For commissioning, connect either the IOP Hand-held Kit or a PC utilizing the STARTER software and the optical cables.

The installation is now completed and the commissioning of the Inverter can now commence.

4.2 General layout of SINAMICS G110D

General layout of SINAMICS G110D

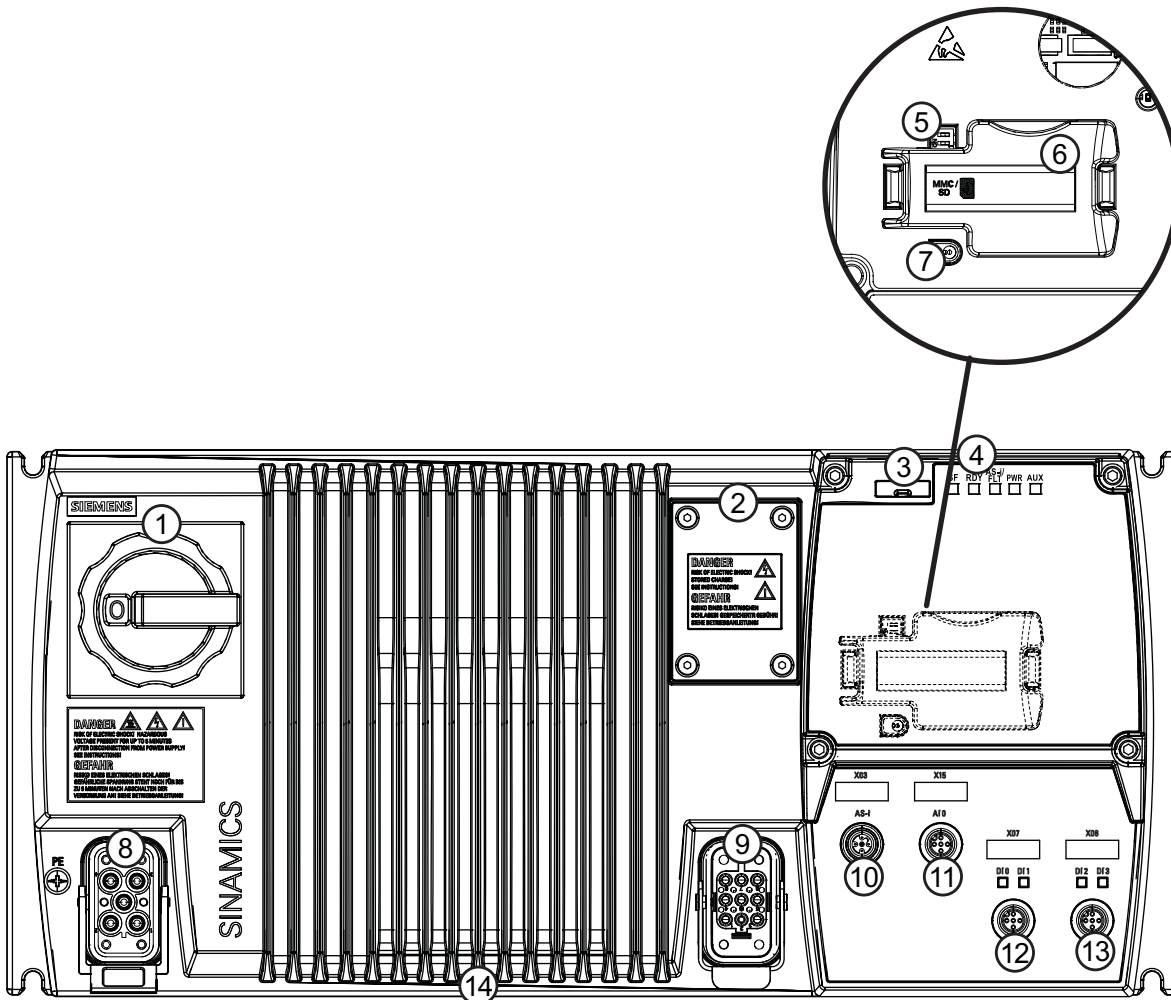

- | | |
|--|--|
| <ol style="list-style-type: none"> 1. Repair switch 2. Braking resistor connection hatch 3. Optical PC connection 4. Status LEDs 5. Analog DIP-switches (underneath CU cover) 6. Optional MMC/SD card holder (underneath CU cover) 7. ASi device address port (underneath CU cover) | <ol style="list-style-type: none"> 8. Mains supply connection 9. Motor, brake and temperature sensor connection 10. AS-i input connection 11. Analog input (A10) 12. Digital inputs (DI0 & DI1) 13. Digital inputs (DI2 & DI3) 14. Heatsink |
|--|--|

Figure 4-1 SINAMICS G110D Inverter

4.3 Removal of CU area cover and braking resistor connection hatch

Removal of CU area cover and braking resistor connection hatch

Should the CU area cover require to be removed, for example, to fit a Memory Card, it should be removed as shown in the diagram below. The braking resistor connection hatch is removed using the same technique.

<p> CAUTION</p> <p>Seals fitted correctly</p> <p>Should the CU area cover or the braking resistor connection hatch be removed from the Inverter, it is important to ensure that the seals around these areas are fitted properly when reassembling the Inverter to ensure the IP65 rating.</p> <p>TN and TT mains supplies</p> <p>The SINAMICS G110D Inverter with the Class A integrated mains filter is only suitable for operation on TN and TT mains supplies.</p>
--

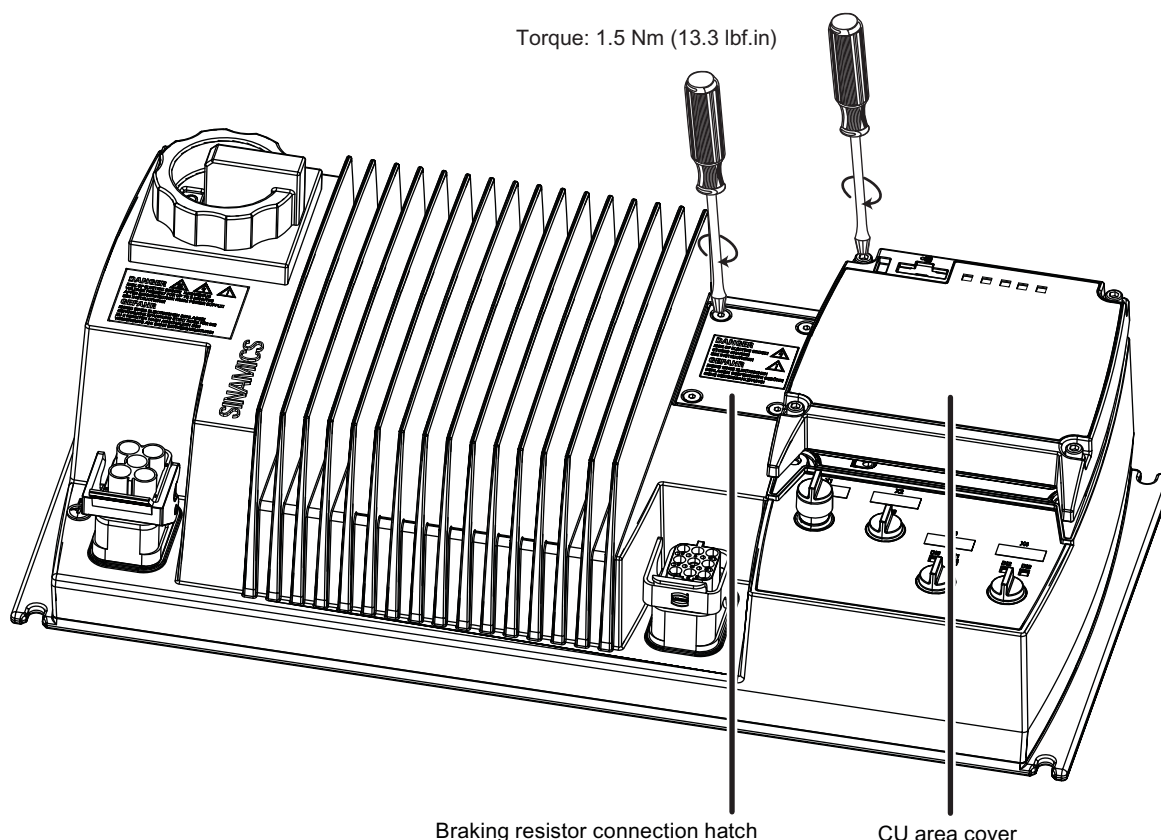

Figure 4-2 Removal of CU area cover and braking resistor connection hatch

4.4 Drill pattern for the SINAMICS G110D

Drill pattern for the SINAMICS G110D Inverter

The Inverter has an identical drill pattern for all frame sizes. The drill pattern, depth and tightening torques are shown in the diagram below.

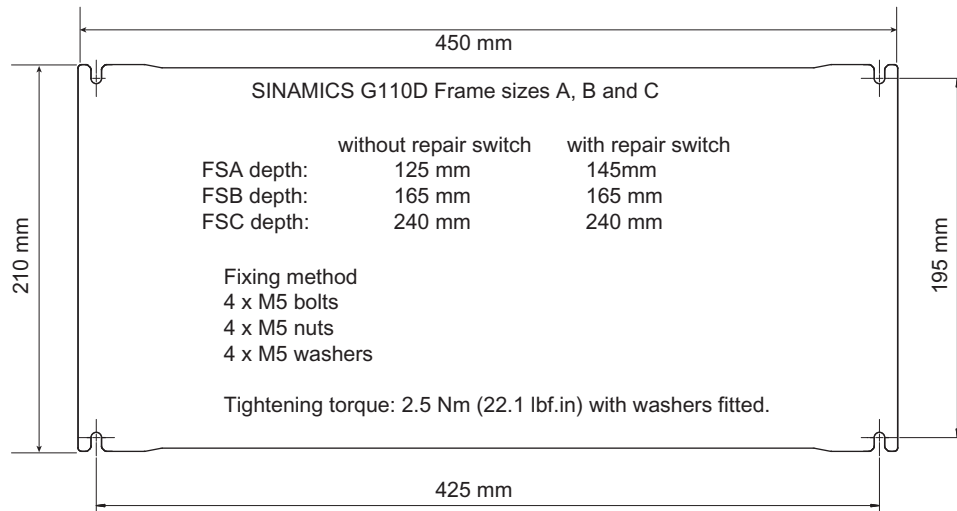

Figure 4-3 Drill pattern SINAMICS G110D

4.5 Mounting orientation

Correct mounting orientation of the Inverter

In the figure below the correct mounting orientation of the Inverter is shown.

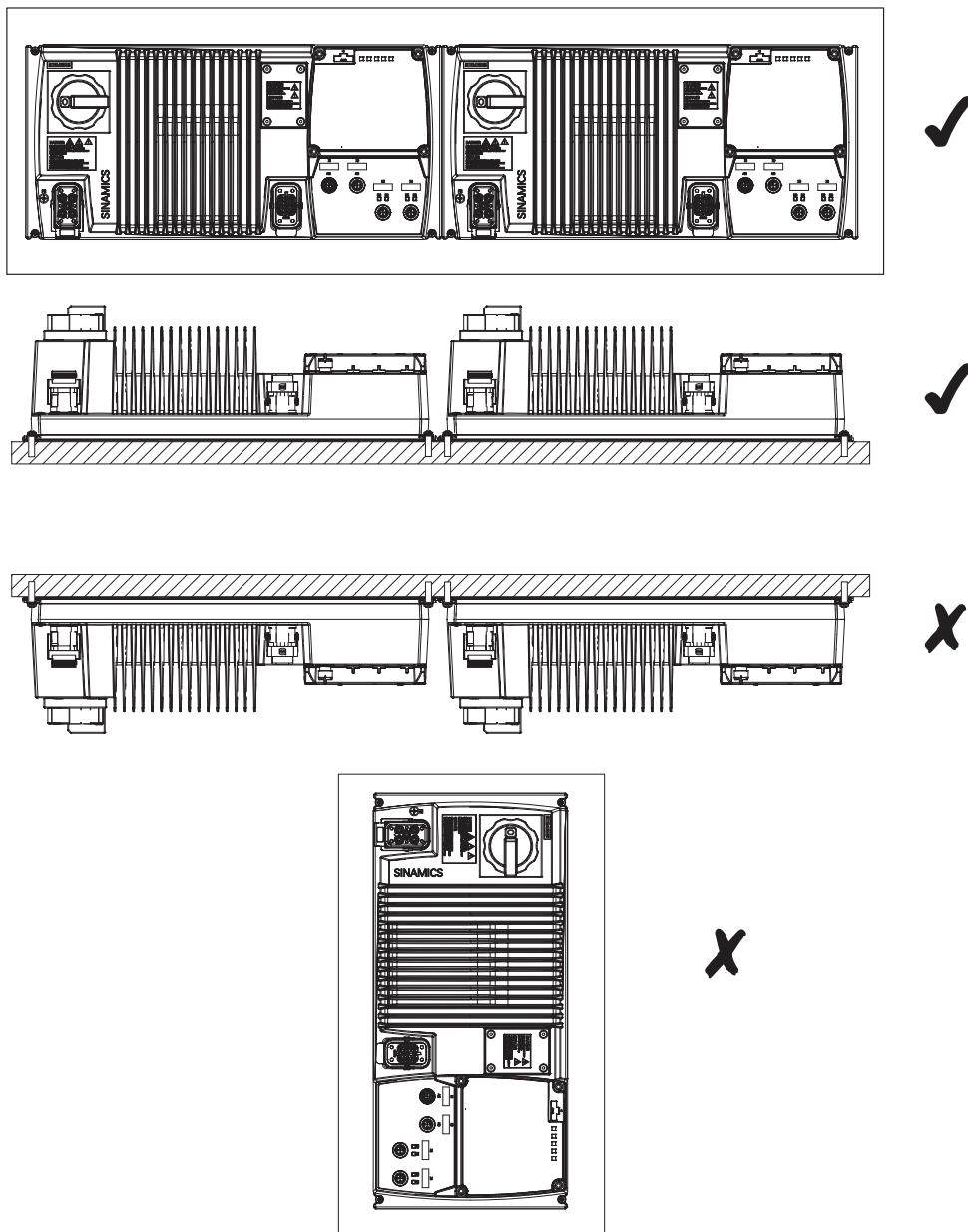

Figure 4-4 Correct Inverter orientation

4.6 Ambient operating conditions

Temperature

The operating temperature range is shown diagrammatically in the figure below:

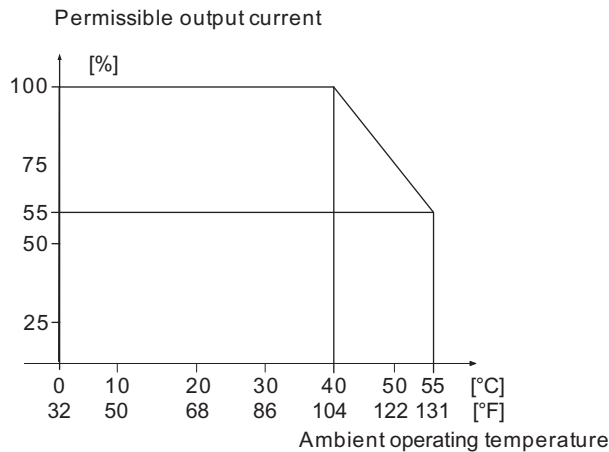

Figure 4-5 Power derating for temperature

Humidity range

Relative air humidity for the Inverter is $\leq 95\%$ non-condensing.

Altitude

If the Inverter is to be installed at an altitude $> 1000\text{ m}$ ($> 3280\text{ ft}$) derating will be required. The figures below show the derating required according to altitude.

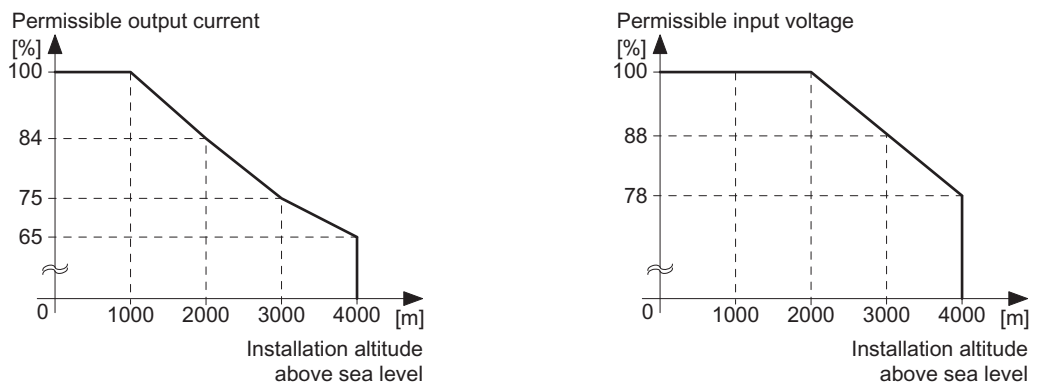

Figure 4-6 Derating for altitude

Shock and vibration

Do not drop the Inverter or expose to sudden shock. Do not install the Inverter in an area where it is likely to be exposed to constant vibration.

Electromagnetic radiation

Do not install the Inverter near sources of electromagnetic radiation.

Atmospheric pollution and water

When fully assembled the inverter has an IP65 rating. This means that the inverter is totally protected against dust and low pressure jets of water. Any unused connections should be covered with the correct sealing caps to ensure the IP65 rating.

4.7 SINAMICS G110D Specifications

SINAMICS G110D specifications

Table 4- 1 Rated Output, Input and Fuses

Product	Frame size	Rated output		HO		Fuse		Circuit breakers	
		kW	hp	Rated output current	Rated input current	A	A	3NA3...	Order Number
6SL3511-...									
0PE17-5AM0	A	0.75	1	2.3	2.0	10	803	3RV1021-1FA10	-
0PE21-5AM0	A	1.5	1.5	4.3	3.9	10	803	3RV1021-1JA10	-
0PE23-0AM0	A	3	4	7.7	7.0	16	805	3RV1021-4AA10	-
0PE24-0AM0	B	4	5	10.2	9.1	20	807	3RV1021-4BA10	-
0PE25-5AM0	C	5.5	7.5	13.2	12.2	20	807	3RV1031-4EA10	-
0PE27-5AM0	C	7.5	10	19	17.9	32	812	3RV1031-4FA10	-

For further technical information, please refer to the Operating Instructions.

Group fusing

Group fusing is where one circuit breaker or fuse is intended to provide protection for two or more devices. The protection device is called a branch circuit protection (BCP) device.

For more information, please read the following FAQ:

<http://support.automation.siemens.com/WW/view/en/35935349>

For additional information please see the following FAQs:

<http://support.automation.siemens.com/WW/view/en/14399444>

<http://support.automation.siemens.com/WW/view/en/23995621>

4.8 Cables and connections

Connections and cables

 WARNING
Switches and contactors Under no circumstances shall any kind of switch or contactor be placed in the circuits between the Inverter and the motor. For maintenance, ensure that the motor cable is unplugged at the Inverter.
Temperature sensor and brake module connections The temperature sensor and brake module connections are at DC link negative potential. Appropriate precautions against touching these connections and appropriate insulation on the cables must be used. The motor terminal box must be kept closed whenever the mains is applied to the Inverter. Cables that are not used should be individually insulated and not earthed.

The following block diagram and tables describe the details and limitations of the connections of the inverter.

Cable lengths

All inverters will operate at full specification with motor cable lengths as follows:

- Screened - 15 m (49 ft)
- Unscreened - 30 m (98 ft)

Note

Brake voltage 180VDC (400VAC with rectifier)

The brake output of the Inverter is designed to be connected directly to the coil of the brake within the motor, that is, no rectifier module is required within the motor. For operation of the Inverter on a 400VAC supply the brake should be rated for approximately 180VDC (400VAC with rectifier). The brake voltage is dependent on the mains supply voltage (brake voltage = mains voltage x 0.45).

The UL approved current rating for the brake output is 600mA.

The maximum current rating for the brake output without UL is 1A.

Brake voltage 205VDC (230VAC with rectifier)

The brake output of the Inverter is designed to be connected directly to the coil of the brake within the motor, that is, no rectifier module is required within the motor. For operation of the Inverter on a 400VAC supply the brake should be rated for approximately 205VDC (230VAC with rectifier). The brake voltage is dependent on the mains supply voltage (brake voltage = mains voltage x 0.9).

The UL approved current rating for the brake output is 600mA.

The maximum current rating for the brake output without UL is 1A.

For operation of a 205VDC brake the parameter P1215 must be set P1215=2.

Analog input DIP-switches

The analogue input can be configured as an additional digital input. In order to achieve this AIN- (X15.4) should be connected to AIN 0V (X15.3) and the digital input should be connected to AIN+ (X15.2). To make this easier a switch has been provided under the control unit cover that, when operated, makes this connection internally. It is also possible to select whether connection X15.1 provides a 10V (10mA) supply, normally used for an analogue input, or a 24V (25mA) supply, normally used for a digital input. See block diagram below for details.

Auxillary (AUX) power

To operate this product, 24V power supplies need to be provided on both the AS-i + / AS-i - and AUX 24V / 0V pins of connector X3. When the product is connected to an AS-i network the 24V power supply on the AS-i + / AS-i - pins is provided by the AS-i network itself. In this case additionally a separate independent 24V power supply must be provided on the AUX 24V / 0V pins.

If the product is not connected to an AS-i network then a 24V power supply still needs to be connected to the AS-i + / AS-i - pins. This can be the same power supply as connected to the AUX 24V / 0V pins as shown in the block diagram below.

Block diagram

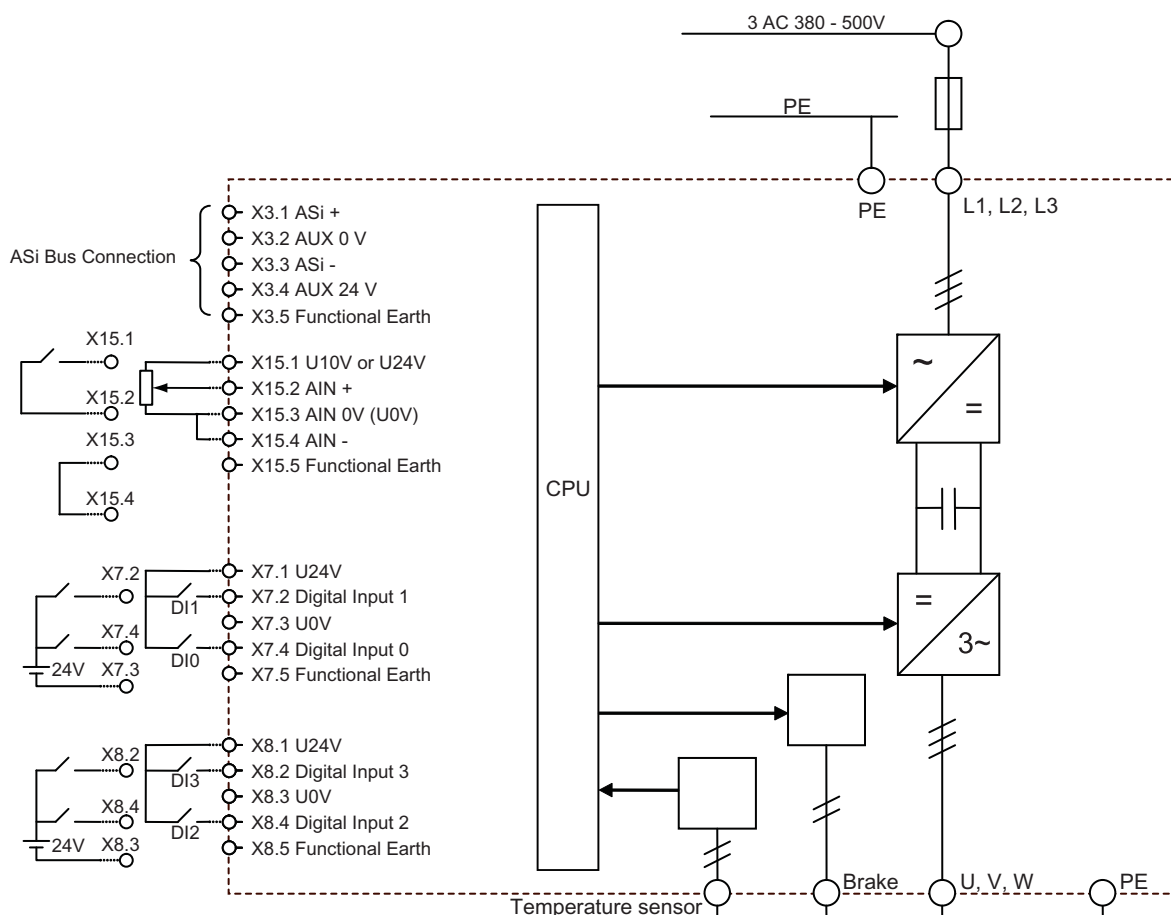

When the SINAMICS G110D is used as a standalone Inverter and is not connected to an AS-i network, an external 24V supply must be used.

In this case the external 24V supply is connected as shown in the diagram opposite, to the AS-i bus connection of the Inverter..

Analog DIP-Switch

Default settings
No internal link X15.3 to X15.4

Link X15.3 to X15.4

X15.1 = U24V X15.1 = 10V

Important:
When the Inverter is operating on an AS-i network the AS-i power supply must be between +31.6 V and +26.5 V. The aux power supply [black cable] is always 24 V ± 15%.

If the Inverter is operating independently of an AS-i network, the external power supply range can be +24 V ± 15%.

To achieve a UL compliant installation the external 24V dc supply must be Class 2 or limited voltage/current according to UL1310; when the SINAMICS G110D is connected to an AS-i network the external 24V power supply must be PELV according to IEC 60364-4-41.

Figure 4-7 SINAMICS G110D block diagram

Cable, connectors and tools specifications

The detailed specifications for the cables, connectors and tools required to manufacture the necessary cables for the SINAMICS G110D are listed in the following tables.

NOTICE
NFPA compatibility
These devices are intended only for installation on industrial machines in accordance with the "Electrical Standard for Industrial Machinery" (NFPA79). Due to the nature of these devices they may not be suitable for installation in accordance with the "National Electrical Code" (NFPA70).

Table 4- 2 Tools

	Harting part number
Crimp tool (Q8/0 and Q4/2)	0999-000-0110
Removal tool (Q8/0)	0999-000-0319
Removal tool (Q4/2)	0999-000-0305
No special tools are required for the Control Unit connectors	

Table 4- 3 Control Unit connectors

Connector	Binder part numbers	
	Straight connector	Right-angle connector
ASI (M12)	99-0436-14-05	99-0436-24-05
Digital input and Analog output (M12)	99-0437-14-05	99-0437-24-05

Table 4- 4 Mains supply connector

Power rating	cable size	cable type	All connector parts are Harting Q4/2				
			Shell	Crimp size	Crimp number	Hood	Gland/Seal
0.75 kW	1.5 mm ²	(3+E) YY	Harting Q4/2 0912 006 3141	1.5 mm ²	0932 000 6204	0912 008 0527	0900 000 5059
1.50 kW	16 AWG	Unscreened		16 AWG			
3.00 kW	2.5 mm ²	(3+E) YY		2.5 mm ²	0932 000 6205	1912 008 0526	
4.00 kW	14 AWG	Unscreened		14 AWG			
5.50 kW	4 mm ²	(3+E) YY		4 mm ²	0932 000 6207		
7.50 kW	12 or 10 AWG	Unscreened		12 or 10 AWG			
4 x crimps are required for each inverter; use 75°C copper wire only							

Connection

4.8 Cables and connections

Table 4- 5 Motor connector

Power rating	cable size	Belcom "DESINA" Cable No.	All connector parts are Harting Q8/0				
			Shell	Crimp size	Crimp number	Hood	Gland/Seal
0.75 kW	1 mm ² 18 AWG	13EBN17Z08P	Harting Q8/0 0912 008 3001	1 mm ² 18 AWG	0933 000 6105	1912 008 0502	1912 000 5057
1.50 kW				2.5 mm ² 14 AWG	0933 000 6102	1912 008 0528	
3.00 kW	2.5 mm ² 14 AWG	13EBN13Z08P		4 mm ² 12 or 10 AWG	0933 000 6107		Lapp MS-SC- M25x1.5 53112640
4.00 kW							
5.50 kW	4 mm ² 12 or 10 AWG	13EBN11Z08P					
7.50 kW							

4 x crimps are required for each inverter for the motor connections; use 75°C copper wire only

Table 4- 6 Temperature sensor and EM brake

Power rating	cable size	Belcom "DESINA" Cable No.	Temperature sensor pair		EM Brake pair	
			Crimp size	Crimp number	Crimp size	Crimp number
0.75 kW	1 mm ² 18 AWG	13EBN17Z08P	0.75 mm ² 20 AWG	0933 000 6114	0.75 mm ² 20 AWG	0933 000 6114
1.50 kW						
3.00 kW	2.5 mm ² 14 AWG	13EBN13Z08P	1 mm ² 18 AWG	0933 000 6105	1 mm ² 18 AWG	0933 000 6105
4.00 kW						
5.50 kW	4 mm ² 12 or 10 AWG	13EBN11Z08P	1 mm ² 18 AWG	0933 000 6105	1.5 mm ² 18 AWG	0933 000 6104
7.50 kW						

2 x crimps are required for each auxiliary signal pair; use 75°C copper wire only

Connection specifications

Table 4- 7 Mains supply and motor output specifications

	Mains supply			Motor output	
	Pin	Function		Pin	Function
	1	L1		1	U
	2	L2		2	Not connected
	3	L3		3	W
	4	-		4	EM Brake (-)
	11	-		5	Temperature sensor (+)
	12	-		6	EM Brake (+)
	PE	Protective Earth		7	V
				8	Temperature sensor (-)
				PE	Protective Earth
	Type	HAN Q4/2 (Male)		Type	HAN Q8 (Female)
Spec.	3AC 380V...500V ± 10%		Spec.	-	

Table 4- 8 Digital input specifications

	Digital input (2 sockets, 4 DIs)	
	Pin	Function
	1	+24 V (25mA max.)
	2	DI1 or DI3
	3	U0V
	4	DI0 or DI2
	5	Functional Earth
	Shield	Functional Earth
	Type	M12 - 5 pole (Female)
	Spec	PNP, SIMATIC-compatible, low < 5 V, high > 10 V, max. input voltage 30V

Table 4- 9 Analog input specifications

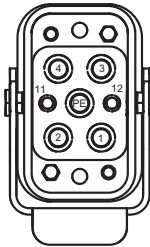
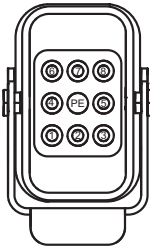

	Analog connections	
	Pin	Function
	1	10V (10 mA) / 24 V
	2	AIN+
	3	0V
	4	AIN-
	5	Functional Earth

Table 4- 10 AS-i connector specifications

	ASi connections			
	Pin	Function	Description	AS-i system cable colour
	1	ASi+	AS-i positive	Yellow
	2	AUX-	Auxiliary 0 V	Black
	3	ASi-	AS-i negative	Yellow
	4	AUX+	Auxiliary 24 V	Black
	5	Function earth	Earth connection	-

4.9 Configuring the AS-i slave

Overview

Before data transfer can take place between the AS-i Master and the slave devices each slave must be assigned an address. The address of a AS-i slave can be assigned using the following methods:

- Addressing off-line using the Siemens Addressing Programmer
- Addressing on-line using the controlling system, such as a PLC via the AS-i Master (it should be noted that only one slave with address 0 may be present on the bus if this method is to be implemented).

The addresses are designated numbers between 1 and 31, with each slave device having a preset address of 0. If the AS-i master detects a slave with address 0, it recognizes the device and can automatically assign an address to the device and integrate the device into the AS-i network (If more than one slave device has the address 0, the automatic address assignment and integration is not possible).

Note



Profile 3.0

Under AS-i Profile 3.0 it is possible to address 62 digital or 62 analog slave devices or a combination of both digital and analog but not exceeding a total of 62 slave devices. This is accomplished by using the A/B address system. For example, two slaves can be assigned as number 1 slave device, by assigning them as 1A and 1B.

The addresses of the slave devices do not have to be sequential, for example the first slave device can have the address 21, the next 10.

Prior to the installation and commissioning of the Inverter, the AS-i communications and devices have to be set-up correctly. The equipment shown in the table below will be necessary for the successful integration of more than one Inverter onto the AS-i bus network.

Table 4- 11 Equipment for installation of SINAMICS G110D (AS-i)

Item	Order Number	
Address cable	3RK1901-3HA01	
AS-i address programmer	3RK1904-2AB01	
AS-i connection kit	3RK1901-1NR21	

Typical AS-i network structure

In the diagram below a typical AS-i network is shown to help visualise the structure and arrangement of an AS-i network.

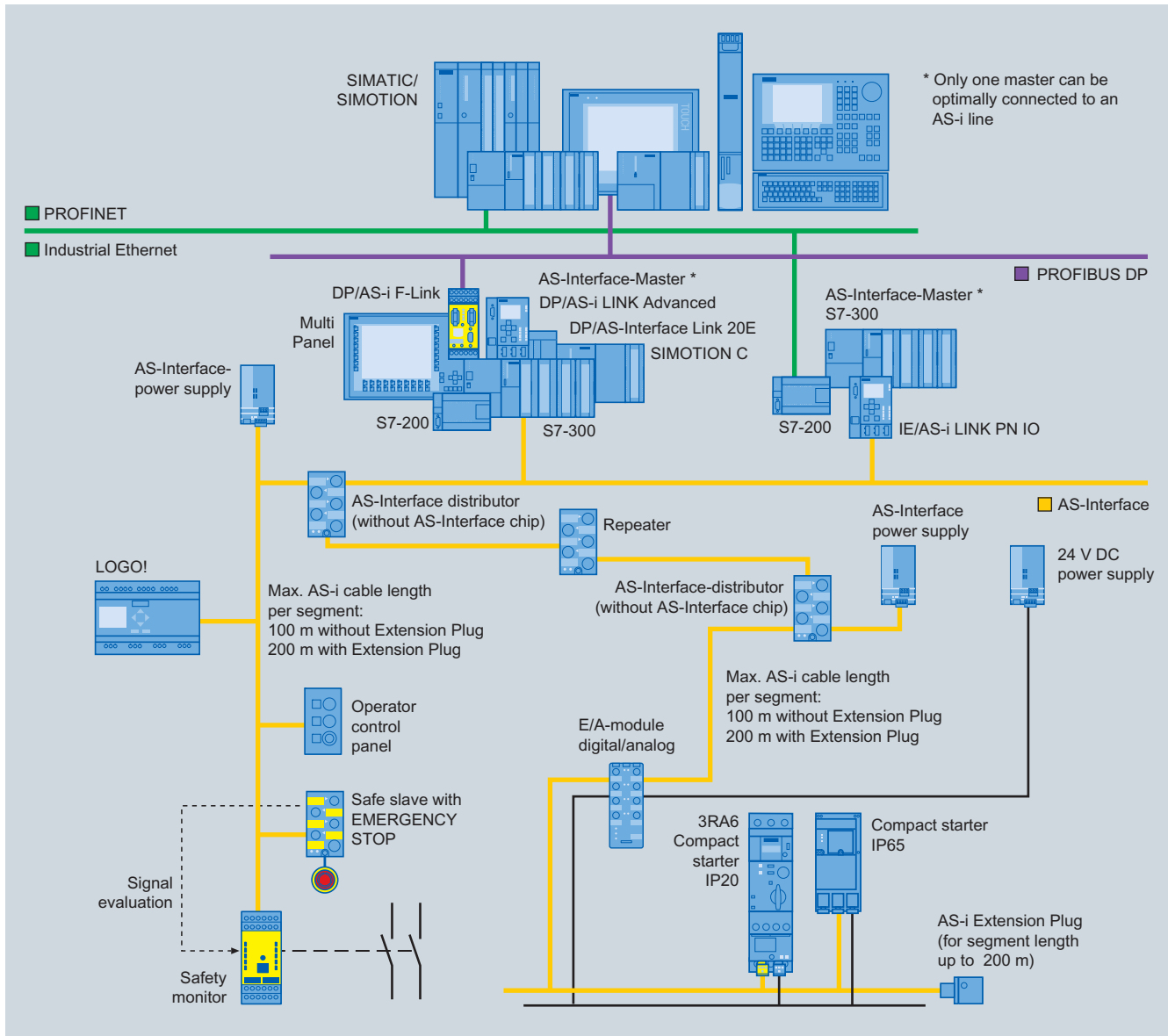

Figure 4-8 Example AS-i configuration

Addressing the AS-i device

To address the AS-i device (in this case, the Inverter), the following actions should be performed.

CAUTION

AS-i Master

The AS-i Master must be disconnected from the network prior to addressing any AS-i slaves. If the AS-i Master is connected to the network during the addressing process, the addressing of an AS-i slave will not be possible.

Addressing Unit

When assigning the address of the slaves in the Inverter with the Addressing Unit, the digital inputs and analog input must be disconnected to prevent the Addressing Unit from being overloaded by their power consumption.

When the Addressing Unit is plugged into the device address port of the Inverter; the AS-i communications are terminated automatically. Therefore there is no requirement to disconnect the M12 AS-i connection on the Inverter.

1. Connect the M12 connector to the Inverter AS-i port ①.
2. Connect the AS-i cable to the M12 branch ②.
3. Remove the Control Unit cover ③.
4. Connect the Address Programmer to the AS-i addressing port on the Inverter ④.
5. The address of the Inverter (as a slave device) can now be completed. See next section for full instructions on address the slaves using the Address Programmer.
6. Refit the Control Unit cover, ensure that the seals are correctly in place to preserve the Inverter IP65 rating.

4.9 Configuring the AS-i slave

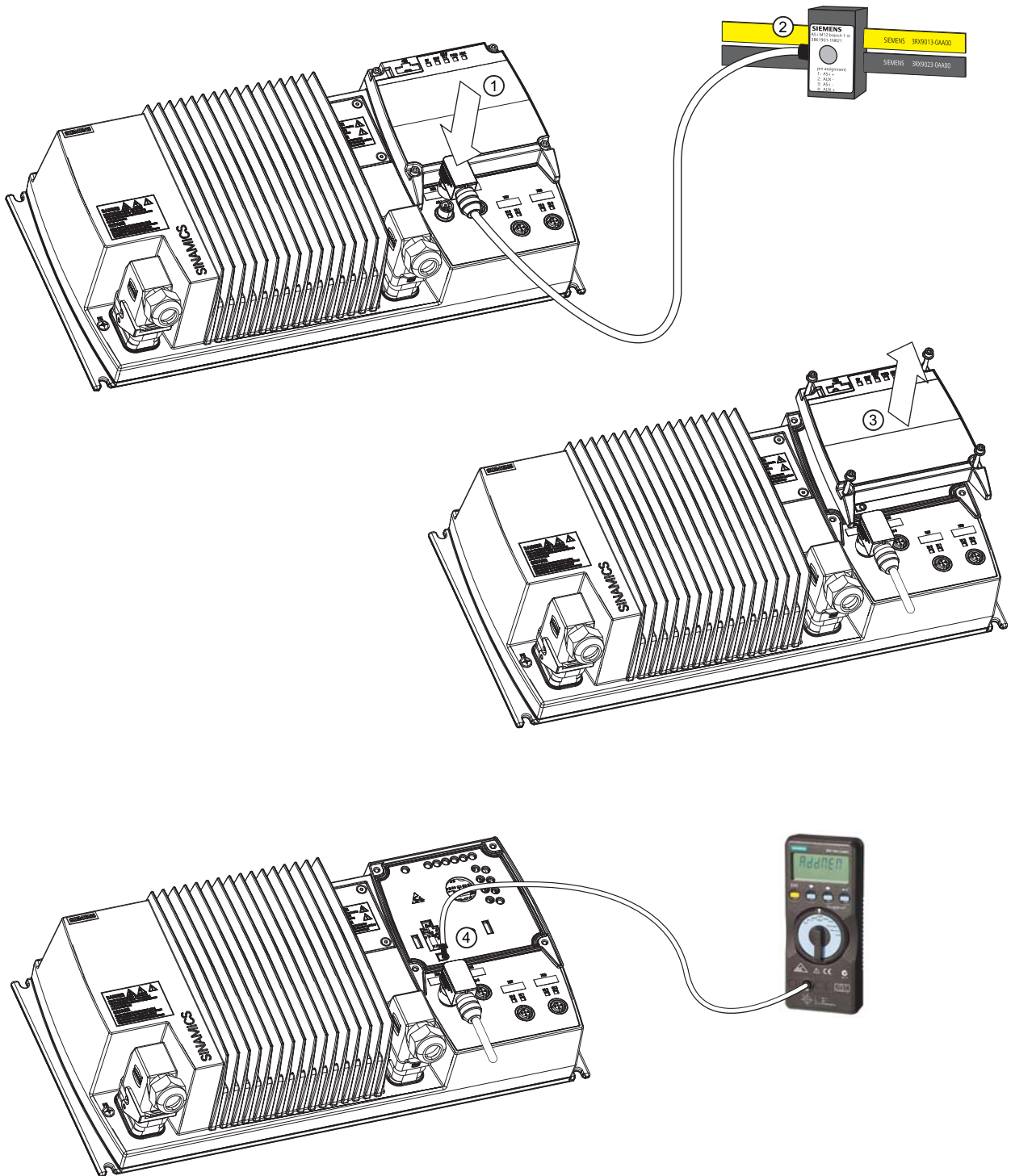

Figure 4-9 Addressing the ASi slave

4.10 Using the AS-i Programmer

Setting the slave address with the AS-i Address Programmer

The Inverter contains two logical AS-i slaves. Either slave can be assigned an address in the range 1A...31A or 1B...31B. The addresses can be allocated to the slaves sequentially, for example, 3A and 4A, 10B and 11B or they can occupy the same number using extended addressing, for example, 20A and 20B. If necessary they can have completely different unassociated addresses, for example, 14A and 16B.

The decision on how to allocate these addresses must also take into account the addressing used in the PLC program by either adherence to the memory map of the AS-i master or the way in which the inputs and outputs can be allocated by the PLC hardware configuration.

The default address of both slaves is 0.

Setting the AS-i address of slave 1



1. Plug the AS-i Programmer into the addressing socket of the Inverter.

2. Turn the dial on the Programmer to the **ADDR** position. The display will indicate that this mode has been selected.



3. Press the  button; the screen will display the text, **SEt 0** with a small flashing **0** to the left of the display.



4. Press the  button until you reach the required number. By pressing both the  and  simultaneously, you can toggle between A and B identifiers of the address.





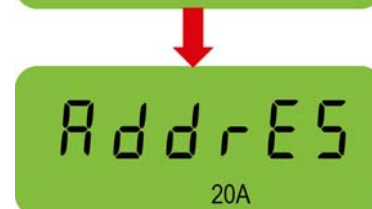

5. Press the  button to confirm the selected address.

ProG is momentarily displayed, followed by **AddrES**.

The number allocated to slave 1 is now shown at the bottom of the display.



Setting the AS-i address of slave 2

1. Press the  button; the display shows the text **SEArCH** followed by **uSE 0**.
A small 0 is displayed to the left of the display and the number of the first slave that has already been allocated to slave 1 is shown at the bottom of the display.
2. Press the  button to select this number.
SEt 0 appears and the small 0 in the left of the display starts flashing.
3. Press the  button until you reach the required number.
By pressing both the  and  simultaneously, you can toggle between A and B identifiers of the address.
4. Press the  button to accept this number.
ProG is displayed briefly.
Both of the numbers allocated to the slaves are now displayed in the lower part of the screen.

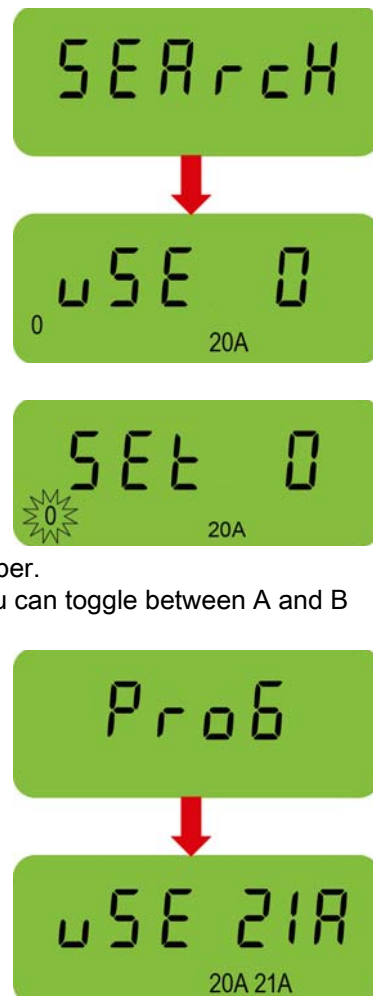

Changing existing addresses of the AS-i slaves

If the allocated addresses used two different numbers, for example, 10A and 11A, then if one of the slave addresses is reset to 0 the other slave is not affected.

If the allocated addresses use the same number, for example, 20A and 20B, then if one slave addresses is reset to 0, then both slaves numbers will be reset to 0.

Modifying an existing address of a single slave within the Inverter will not affect the address of the other slave.



To change an existing address of a slave, the following procedure should be performed:

1. Plug the AS-i Programmer into the addressing socket of the Inverter
2. Turn the dial on the Programmer to the **ADDR** position. The display will indicate that this mode has been selected.

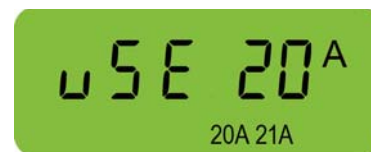

3. Press the  button; the screen will display **uSE** and the number of the lower addressed slave. The existing slave addresses are shown at the bottom of the display.



4. Press the  and  buttons to select the slave address number to be changed.
5. Press the  button; the display now shows **SEt**. The selected number will begin to flash.



6. Press the  and  buttons to select the new slave address number.



7. Press the  button to confirm the new address. **ProG** is displayed briefly followed by confirmation of the address change.



Commissioning

5.1 Typical commissioning scenarios

Alternative commissioning options

The functions of the Inverter are activated and configured using parameters. Parameters can either be accessed from the operator control/display instrument (Operator Panel) or using the STARTER software from the PC using the appropriate Inverter interface.

Parameter information and data can also be accessed and modified over the AS-interface. For further details please see the section "Operation in fieldbus system".

Inverters can also be parameterized by saving the valid Inverter parameter set on an SD/MMC memory card then transferring it to a different Inverter with the same configuration and function.

The commissioning scenarios listed below are described in the following sections:

- Commissioning, using the factory settings
- Commissioning with the STARTER software
- Commissioning using the Operator Panel
- Data backup with the SD/MMC memory card

Users can access the inverter parameters via the following interfaces

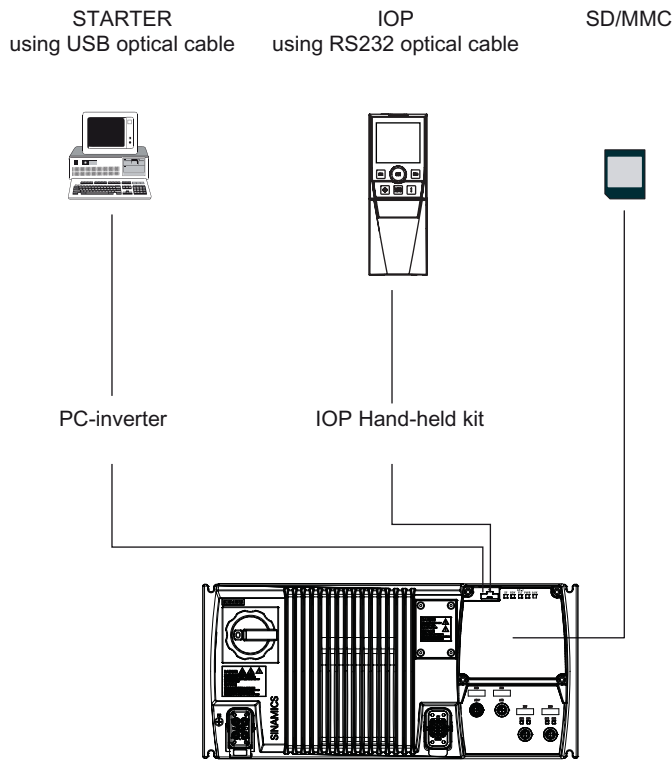

Figure 5-1 Communications interfaces

5.2 Restoring the factory settings

If nothing else works, restore the factory settings!

You can restore the factory settings using parameter P0970.

Parameter or procedure	Description
P0003 = 1	User access level 1: Standard level
P0010 = 30	Commissioning parameter 30: Factory setting, parameter transfer
P0970 = 1	Restore factory settings 1: Restore the factory parameter settings
IOP - select factory restart from the extras menu.	The IOP will display a message stating that a factory reset is taking place and display a progress bar. When completed the display will display a message that the factory reset has been successfully completed.
STARTER	Displays a progress bar.

Note

Data transfer is interrupted while the factory parameter settings are being restored.

The following parameters remain unchanged even after the factory settings have been restored:

- P0014 Storage mode
 - P0100 Europe / North America
 - P0201 Power stack code number
 - Communication parameters
 - Power-Module-specific data
-

5.3 Preparing for commissioning

Prerequisites: before you start

Before you start parameterization, you should clarify the following issues about commissioning your application.

Are the factory settings sufficient for your application?

Check which factory settings can be used and which need to be changed (see Section 'Commissioning with factory settings'). When doing so, you may find that you only need to change just a few parameters.

Which motor are you using? [P0300]

- A synchronous or induction motor?

The SINAMICS Inverters are preset in the factory for applications using 4-pole three-phase induction motors that correspond to the performance data of the frequency inverter.

Motor data / data on the motor rating plate

If you use the STARTER software and a SIEMENS motor, you only have to specify the Order No of the motor. In all other cases, you must read-off the data from the motor rating plate and enter the data into the appropriate parameters.

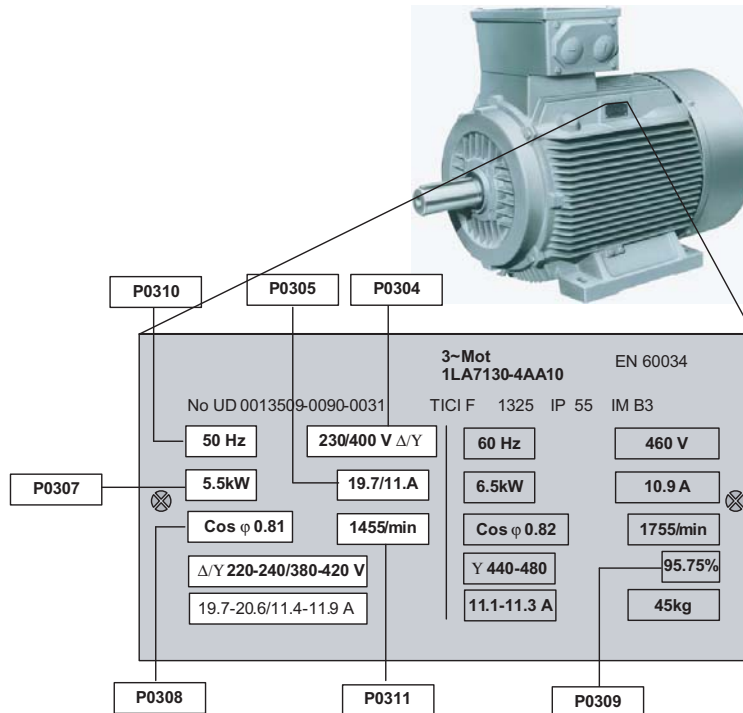

Figure 5-2 Rating plate data as parameters

NOTICE

Information about installation

The rating plate data that you enter must correspond to the connection type of the motor (star/delta), i.e. with a delta motor connection, the delta rating plate data must be entered.

In which region of the world is the motor used? - Motor standard [P0100]

- Europe ICE: 50 Hz [kW] - factory setting
- North America NEMA: 60 Hz [hp] or 60 Hz [kW]

What is the prevailing temperature where the motor is operated? [P0625]

- Motor ambient temperature [P0625], if it differs from the factory setting = 20° C.

What control mode do you want to use for your application? [P1300]

There are variety of settings for P1300; the default being 0, which is V/f with linear characteristic. This setting is suitable for most applications. For further information, refer to the Parameter List for the SINAMICS G110D.

What command and setpoint sources are you using?

The command and setpoint sources that are available depend on the Inverter. The SINAMICS G110D by default uses the fieldbus interface.

- **Possible command sources [P0700]**
 - Operator Panel
 - Fieldbus (default setting for the SINAMICS G110D Inverters)
 - Local digital inputs/switches
- **Possible setpoint sources [P1000]**
 - Motorized potentiometer
 - Analog setpoint
 - Fixed frequency (default setting for the SINAMICS G110D Inverters)
 - Fieldbus

Minimum/maximum frequency of the motor

The minimum and maximum frequency with which the motor operates or is limited regardless of the frequency setpoint.

- Minimum frequency [P1080] - factory setting 0 Hz
- Maximum frequency [P1082] - factory setting 50 Hz

Ramp-up time and ramp-down time

The ramp-up and ramp-down time define the maximum motor acceleration when the speed setpoint changes. The ramp-up and ramp-down time is the interval between motor standstill and the maximum frequency, or between the maximum frequency and motor standstill.

- Ramp-up time [P1120] - factory setting 10 s
- Ramp-down time [P1121] - factory setting 10 s

5.4 Prerequisites of using the factory settings

Prerequisites for using the factory settings

In simple applications, commissioning can be carried out just using the factory settings. This section explains what prerequisites must be fulfilled for this purpose and how they are fulfilled.

1. The Inverter and motor must match one another; otherwise you must perform a complete *quick commissioning* (this can be performed using the IOP Hand-held Kit or STARTER).
2. The binary and analog inputs must be connected in accordance with the requirement of the application.
3. You then have to "tell" the Inverter the following,
 - the source of its commands:
 - from an operator panel,
 - from the digital inputs
 - from the fieldbus interface (default setting of the SINAMICS G110D)

You can change this *command source* using parameter P0700 if the factory setting is not appropriate for your application.

- where it gets its speed setpoint (setpoint source)
 - from an analog input (analog setpoint)
 - as fixed frequency from a digital input (default setting of the SINAMICS G110D)
 - from the fieldbus interface

You can change this *frequency setpoint source* using parameter P1000 if the factory setting is not appropriate for your application.

5.5 Factory settings for the Inverter

Default command and setpoint sources

Inverters used in automation solutions have the appropriate fieldbus interfaces. These Inverters are preset in the factory so that the appropriate control and status signals can be exchanged using the fieldbus interface.

Table 5- 1 Command and setpoint sources

Parameter	Description
P0700 = 6	Select the command source Fieldbus
P1000 = 3	Select the setpoint source Fixed frequencies

Table 5- 2 Factory setting of additional important parameters

Parameter	Factory setting	Meaning of the factory setting	Function	Access level
P0003	1	Access to the most frequently used parameters	Selecting the user access level	1
P0004	0	All parameters are displayed	Parameter filter: filters parameters in accordance with the functionality	1
P0010	0	Ready to be entered	Commissioning parameter	1
P0100	0	Europe [50 Hz]	Frequency of the regional supply network <ul style="list-style-type: none"> IEC, Europe NEMA, North America 	1
P0300	1	Induction motor	Select the motor type (induction motors / synchronous motor)	2
P0304	400	[V]	Rated motor voltage (in accordance with rating plate in V)	1
P0305	depends on the Power Module	[A]	Rated motor current (in accordance with rating plate in A)	1
P0307	depends on the Power Module	[kW/hp]	Rated motor output (in accordance with the rating plate in kW/hp)	1
P0308	0	[cos phi]	Rated motor power factor (in accordance with rating plate in cos 'phi') when P0100 = 1.2, then P0308 is irrelevant	1
P0309	0	[%]	Rated motor efficiency (in accordance with rating plate in %) when P0100 = 0, then P0309 is irrelevant	1
P0310	50	[Hz]	Rated motor frequency (in accordance with rating plate in Hz)	1
P0311	1395	[rpm]	Rated motor speed (in accordance with rating plate in rpm)	1
P0335	0	Non-ventilated: Shaft-mounted fan in the motor	Motor cooling (specify the motor cooling system)	2
P0625	20	°C	Ambient temperature of motor	3
P0640	200	[%]	Motor overload factor (entered in % referred to P0305)	2
P0700	6	6 (default setting)	Select the command source	1
P0727	0	DI0: On / off DI1: Direction reversal	Control response when the motor starts (start, stop, reverse)	3
P0970	0	Blocked	Restore factory settings	1
P1000	3	Fixed frequencies	Select the source of the frequency setpoint (setpoint input)	1
P1080	0	[Hz]	Minimum frequency	1
P1082	50	[Hz]	Maximum frequency	1
P1120	10	[s]	Ramp-up time	1
P1121	10	[s]	Ramp-down time	1
P1300	0	V/f control with linear characteristic	Control mode	2
P3900	0	No quick commissioning	Completes the quick commissioning.	1

5.6 Commissioning with STARTER

Basic commissioning

The STARTER software uses a series of dialogs to guide the user through the basic commissioning of the Inverter. For specific application configuration and parameterization the expert list within STARTER should be used.

Note

STARTER knowledge

This procedure assumes that you have a working knowledge of the STARTER software.

What do you need?

The following items are required to commission the Inverter with STARTER:

- The PC connection cable - order number: 3RK1922-2BP00 or the USB connection cable - order number: 6SL3555-0PA00-2AA0.
- STARTER software installed on your PC - order number: 6SL3072-0AA0-0AG0 (the version of STARTER should be version 4.1 Service Pack 3 or higher).

Note

PC connection cable 3RK1922-2BP00

Version E02 or higher of the PC connection cable should be used with the SINAMICS G110D/G120D Inverter.

Commissioning procedure

Once STARTER is running it will present an empty screen - from the File menu selected new project.

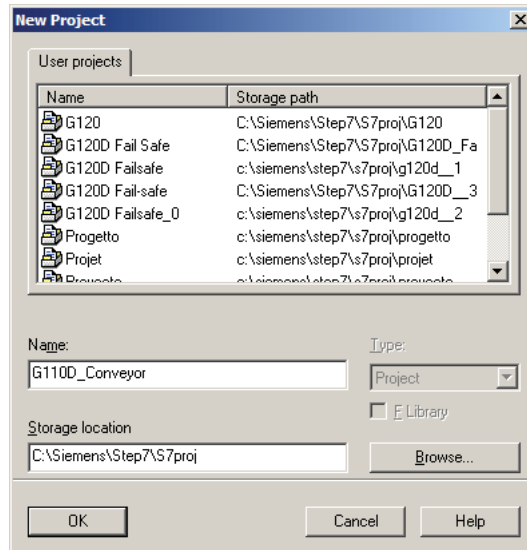

Figure 5-3 Create new project dialog

Click OK and the dialog disappears and the normal STARTER screen appears with the project name appears in the project tree on the right-hand side of the screen.

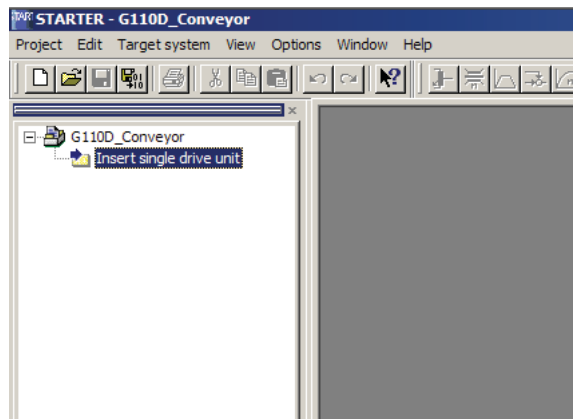

Figure 5-4 Insert drive

Double-click the "Insert single drive unit"; the select drive dialog appears.

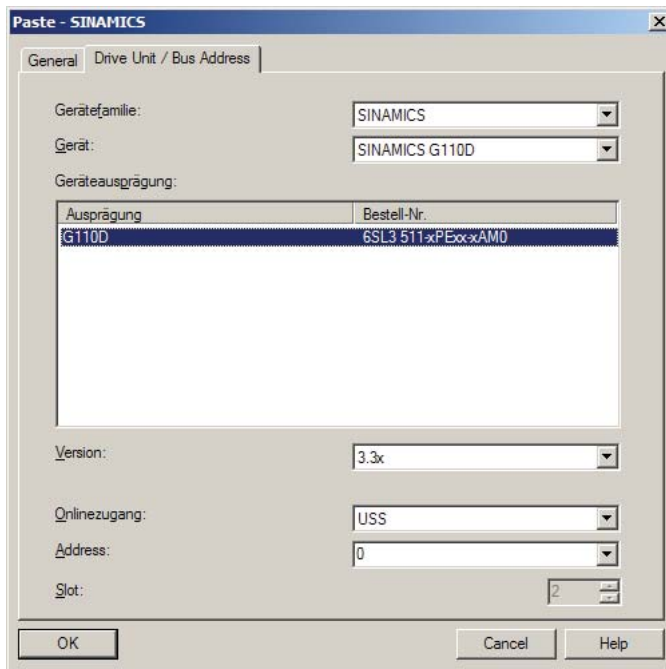

Figure 5-5 Select drive dialog

Select the appropriate Inverter and click OK.

The inserted drive will appear in the project tree.

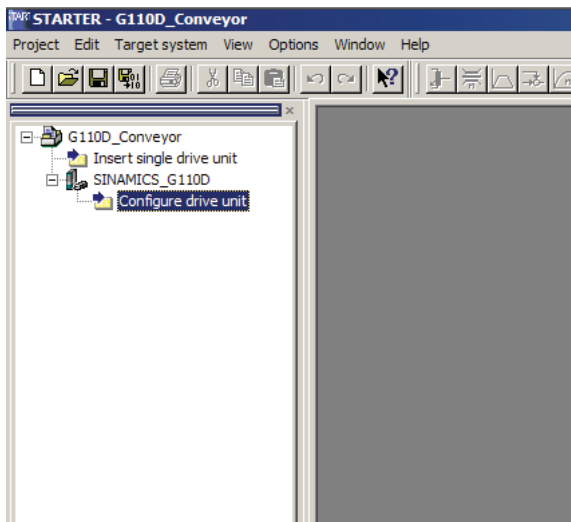

Figure 5-6 Configure drive unit

Double-click "configure drive unit"; the select Inverter dialog will appear.

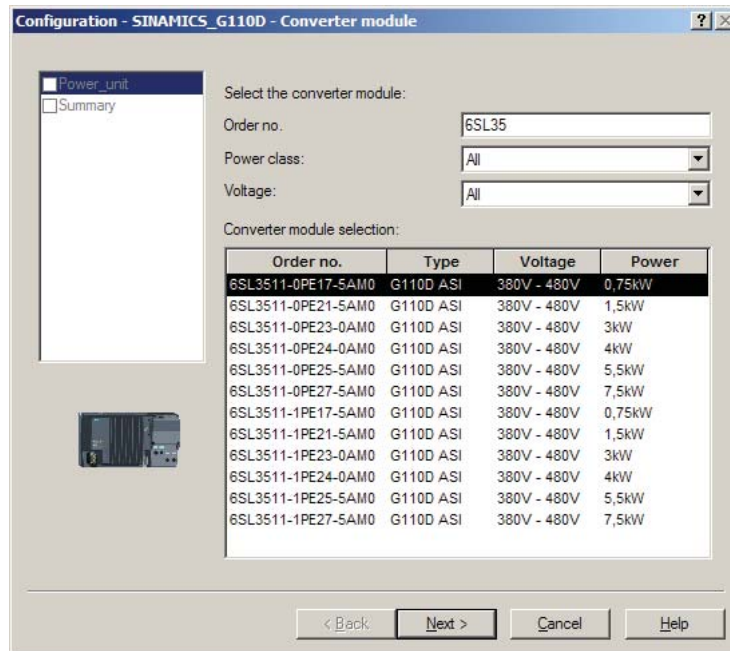

Figure 5-7 Select power unit dialog

Using the order number of the Inverter, select the appropriate Inverter power unit.
Press "next" to display the summary screen.

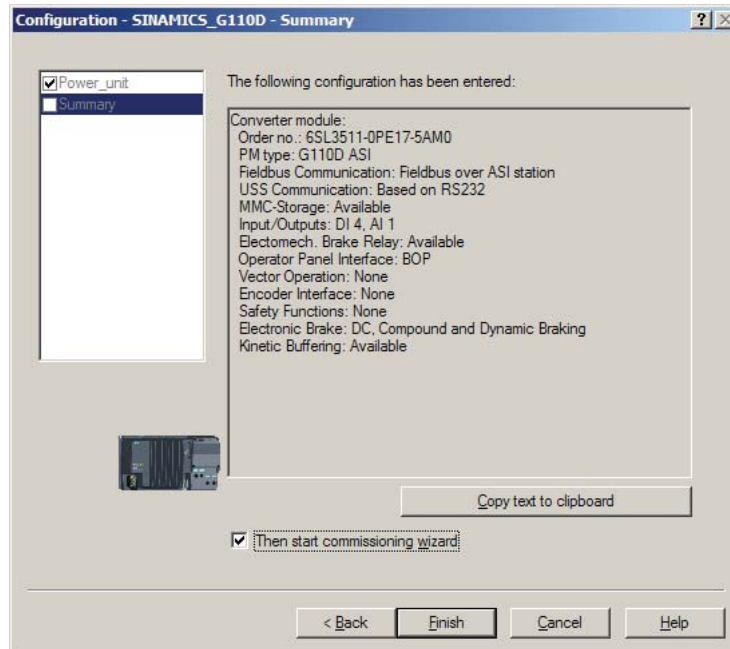

Figure 5-8 Summary dialog

The summary screen displays the configuration settings that have been completed up to this point of the process. The details of the configuration can be copied to the clipboard and pasted into another application such as Notepad to allow a permanent record of the configuration to be stored.

Ensure that "Then start commissioning wizard" is selected and click "Finish".

The "Control Method" dialog is displayed.

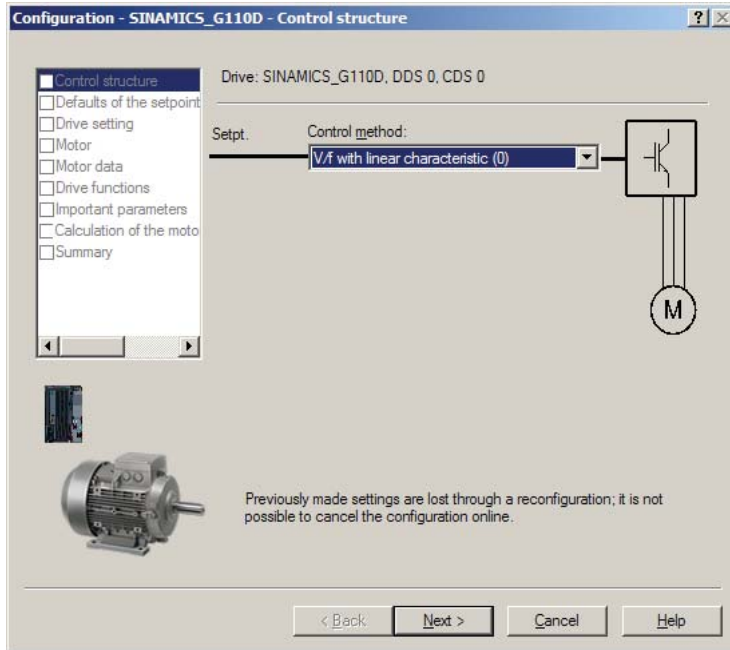

Figure 5-9 Select control method dialog

Select the required control method and click "Next". The command and setpoints source dialog is displayed.

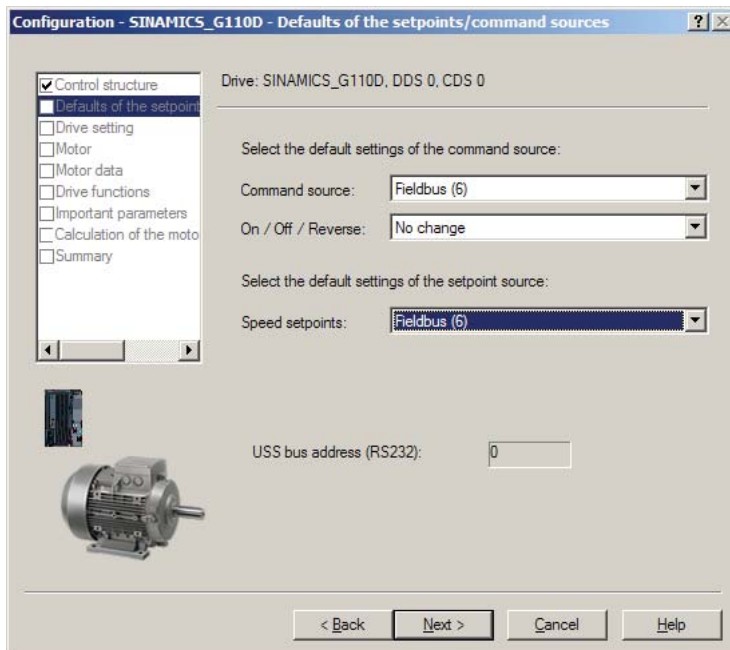

Figure 5-10 Select command and setpoint source dialog

The default command and setpoint source for the Inverter is Fieldbus.

Click "Next". The drive setting characteristics dialog is displayed.

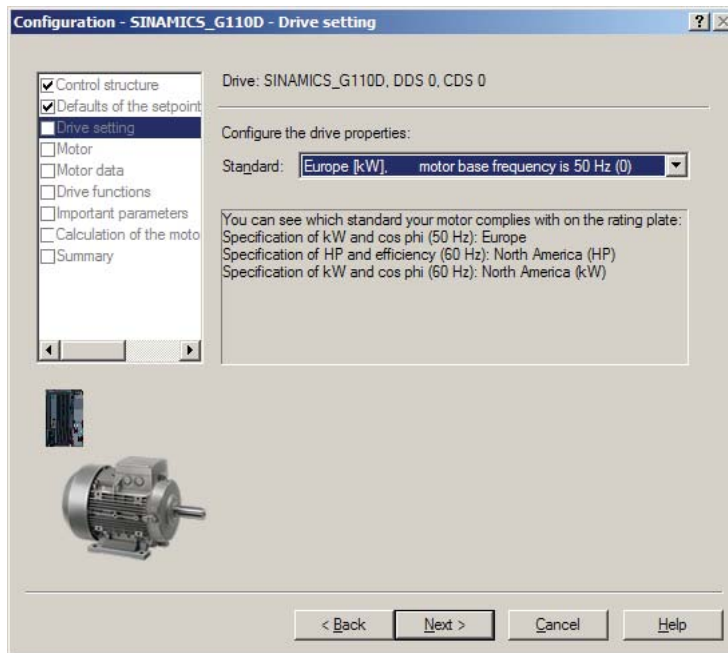

Figure 5-11 Select drive settings dialog

Select the appropriate settings for your region and supply characteristics.
Click "Next". The Motor dialog is displayed.

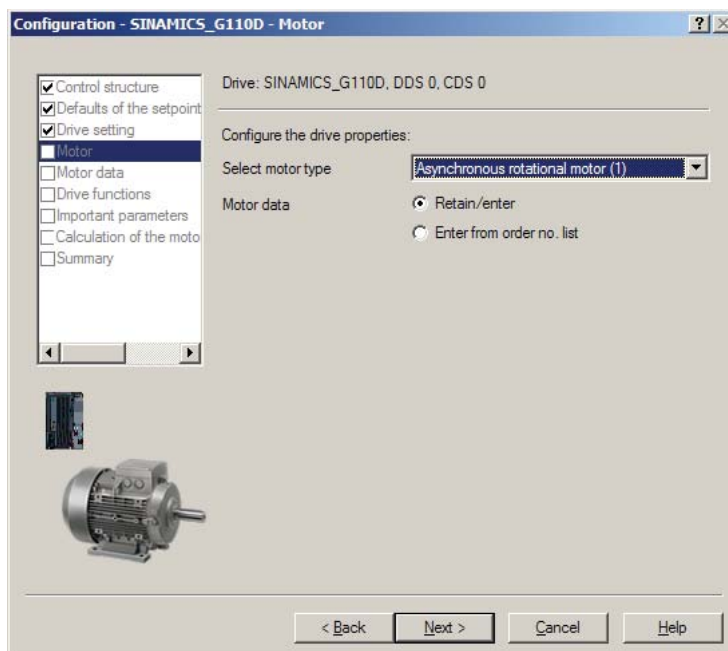

Figure 5-12 Select motor type dialog

Select the type of motor to which the Inverter is connected. Click "Next"; the motor data dialog is displayed.

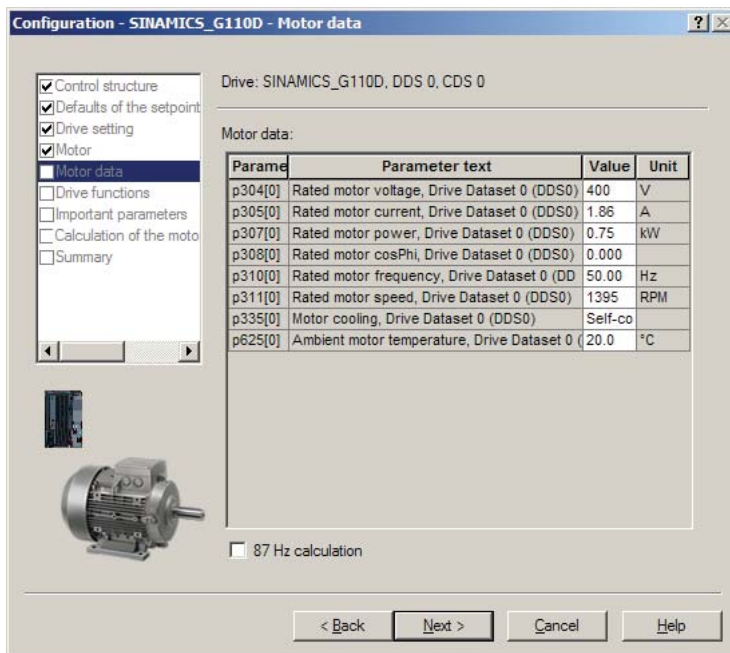

Figure 5-13 Motor data dialog

Enter the motor data, which can be found on the motor rating plate. Click "Next"; the Motor identification dialog is displayed.

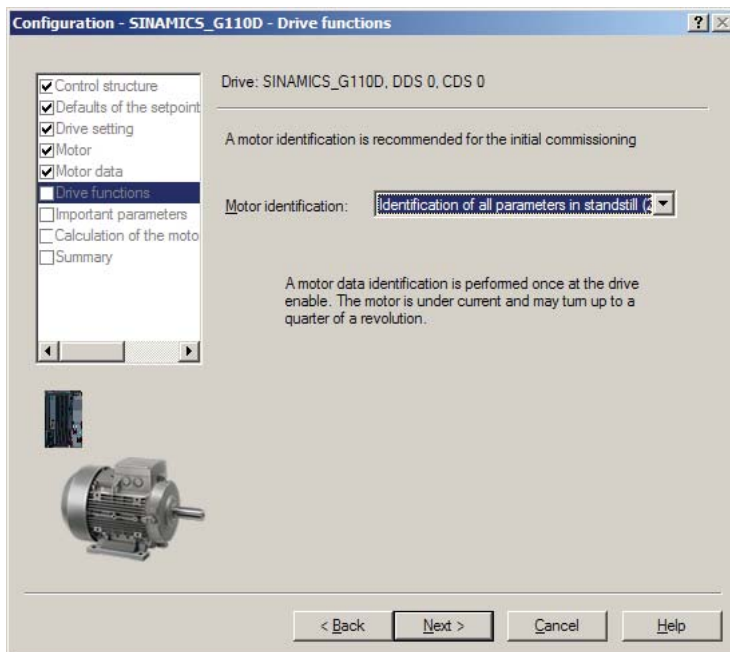

Figure 5-14 Motor identification dialog

Select which type of motor identification is required. It is recommended that a motor identification is actually completed. Click "Next"; the Important parameters dialog is displayed.

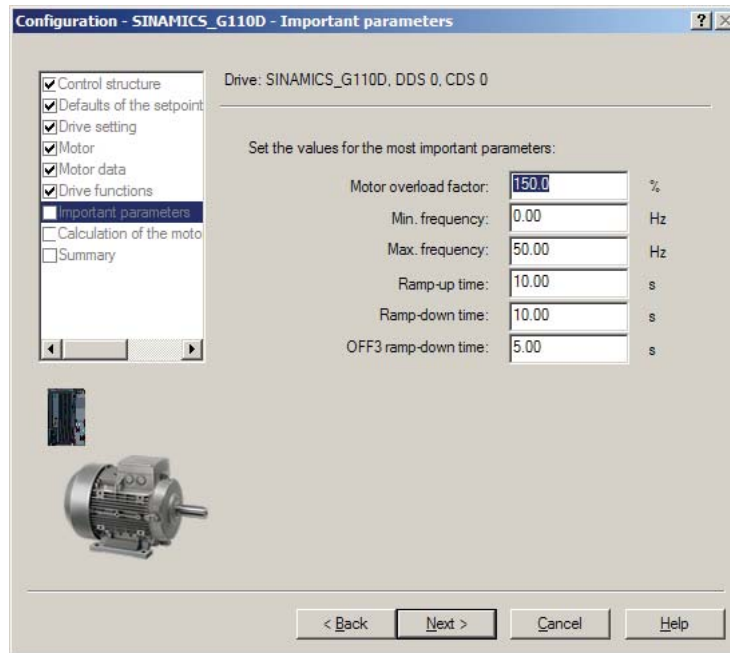

Figure 5-15 Important parameters dialog

Enter the values for the listed parameters. Click "Next"; the motor calculation dialog is displayed.

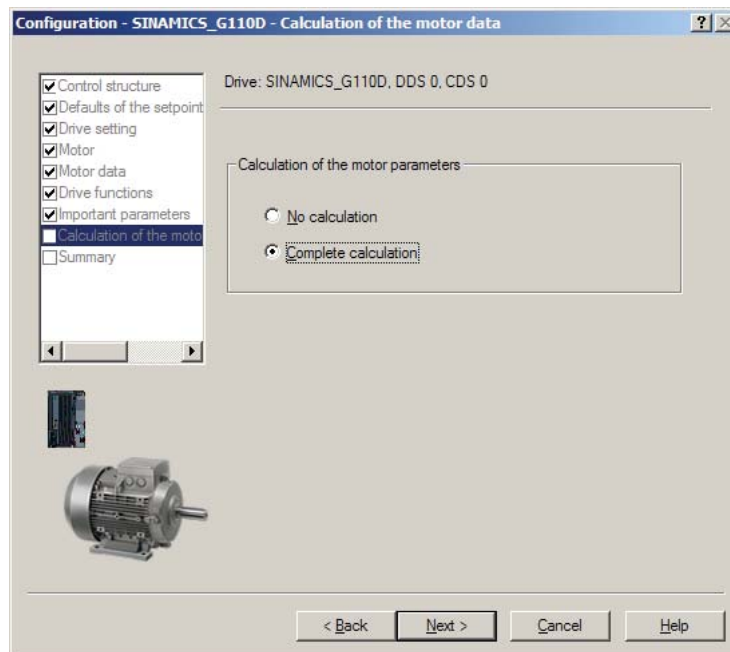

Figure 5-16 Calculate motor data dialog

Select "complete calculation" and click "Next"; the summary screen will be displayed.

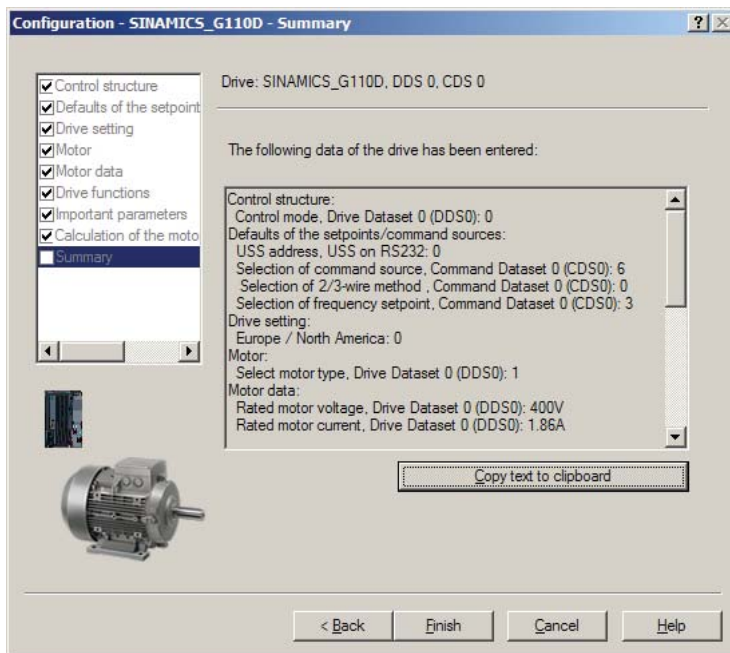

Figure 5-17 Configuration summary

The summary information can be copied to the clipboard for pasting into another application, such as, Notepad as a permanent record of the configuration.

Click "Finish".

To complete the basic commissioning of the Inverter, the following tasks must be completed:

- Ensure that the Inverter and motor are powered-up (no run command should be issued).
- Ensure that the Inverter is correctly connected to the PC, using the appropriate communications cable.

In the project tree under commissioning, select "Control panel". The control panel will appear at the bottom of the screen.

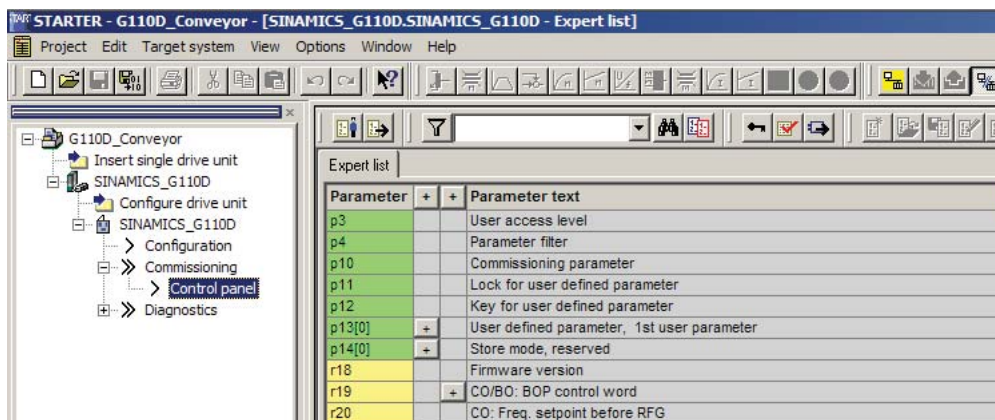

Figure 5-18 Control panel activation

Press the Start [I] button and the motor calculation will be performed. When this has been completed, the basic commissioning of the Inverter and motor has been completed.

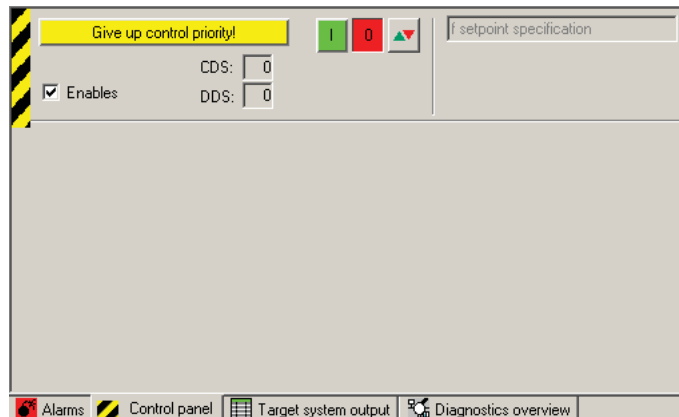

Figure 5-19 STARTER control panel

Commissioning the application

To specifically parameterize the Inverter for an application, the "Expert list" should be used to gain access to any of the required parameters. The values can be modified from within STARTER.

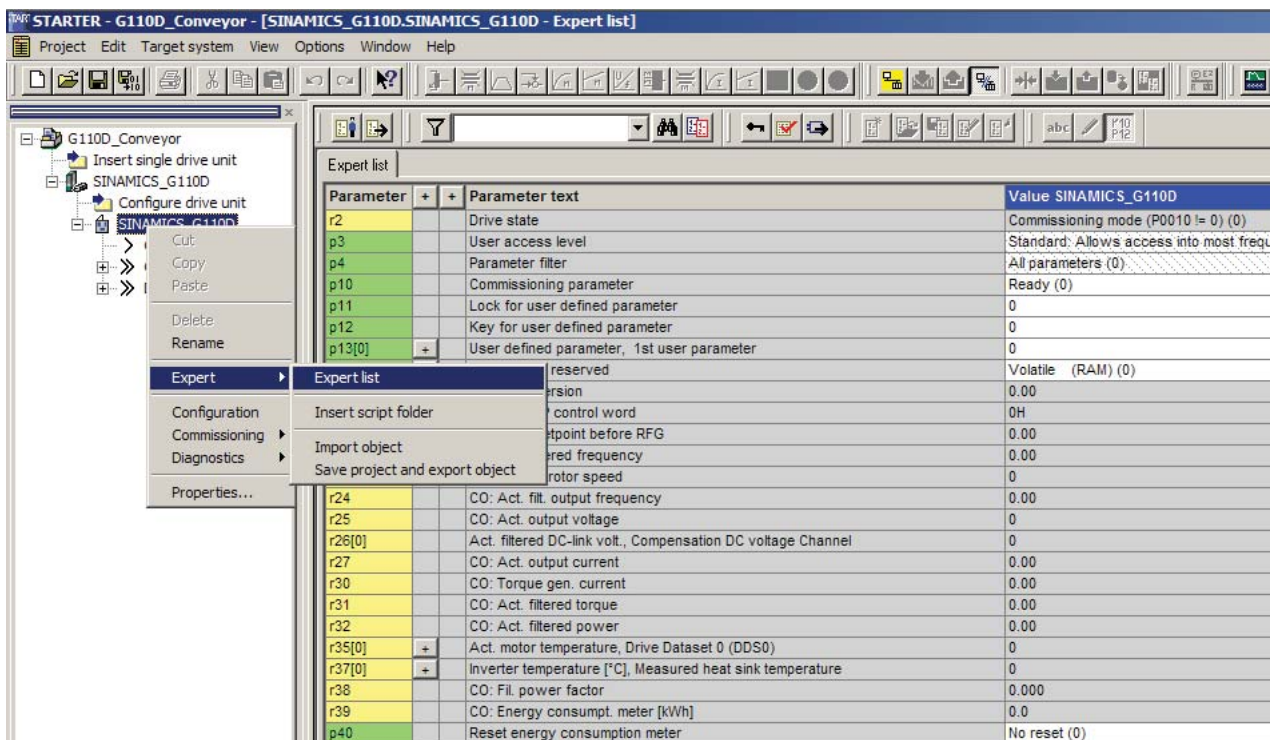



Figure 5-20 Expert list

Saving parameter data

While the STARTER is online and connected to Inverter it is possible to save all the parameter data and configuration data to the Inverter by uploading the data to the Inverter memory.

To upload the data to the Inverter, simply press .

5.7 Commissioning with the IOP

Functions of the Intelligent Operator Panel (IOP)

The Intelligent Operator Panel (IOP) has been designed to enhance the interface and communications capabilities of SINAMICS Inverters.

The IOP Hand-held Kit is required to connect the IOP to the Inverter. The IOP should automatically recognise the devices from the SINAMICS range.

The IOP provides support, using the USB connection utilizing a PC, for the following functions:

- Downloading of wizards
- Downloading additional languages

Note

IOP functional support

- Devices prior to version 3.0 firmware may not be fully supported by the IOP.
 - The actual menu structure and functionality of the IOP will be influenced by the following factors:
 - The software version and type of Control Unit to which the IOP is fitted.
 - The firmware and software version of the IOP.
 - The selected functional group filtering of the parameters.
-

Layout and functions

The physical layout of the IOP is shown below:

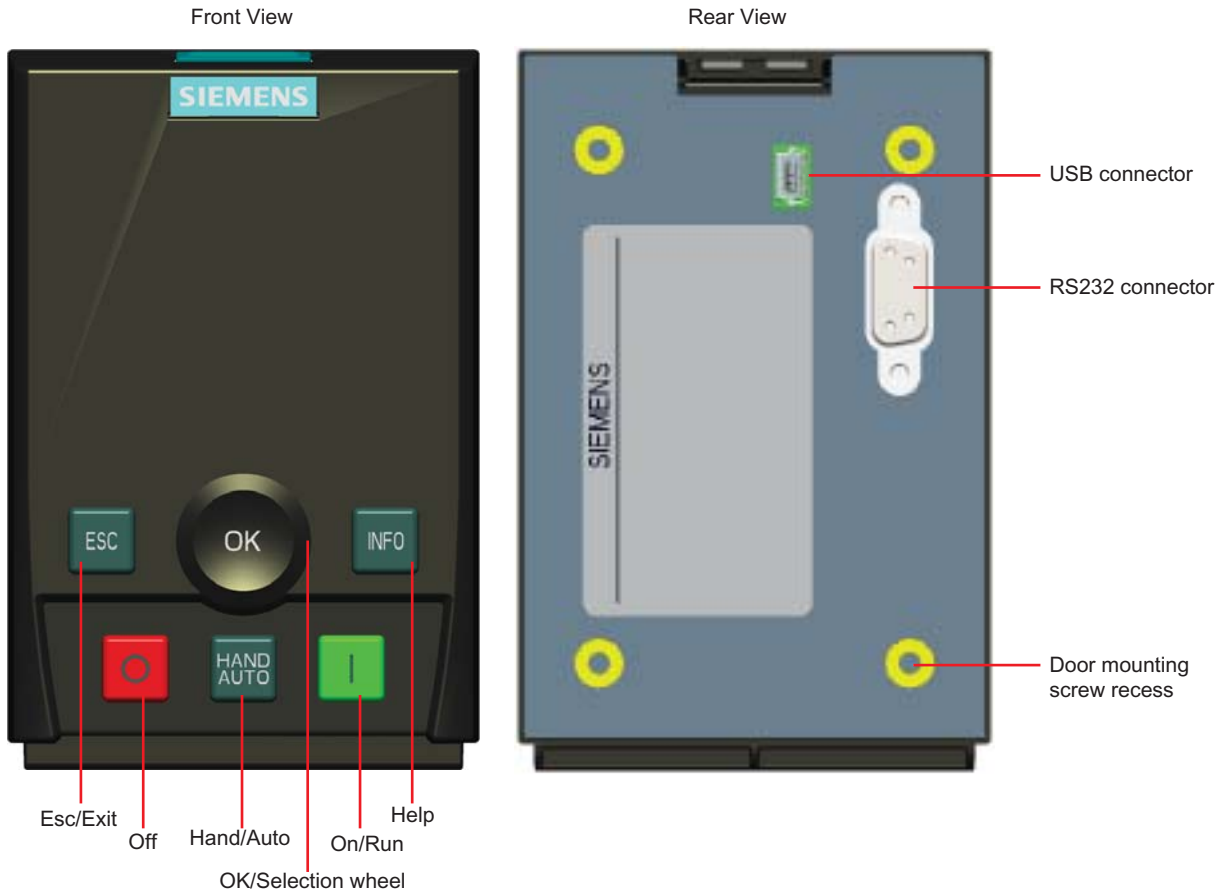







Figure 5-21 Layout of IOP

The IOP is operated by using a push-wheel and five additional buttons. The specific functions of the push-wheel and buttons are shown in the table below.

Table 5- 3 Function of the IOP controls

Key	Function
	<p>The push-wheel has the following functions:</p> <ul style="list-style-type: none"> • In a menu, turning the push-wheel changes the selection. • When a selection is highlighted, pressing the push-wheel confirms the selection. • When editing a parameter, turning the push-wheel changes the displayed value; clockwise increases the value and anti-clockwise decreases the displayed value.
	<p>The ON key has the following functions:</p> <ul style="list-style-type: none"> • In AUTO mode, the screens displays an information screen, stating that the command sources is AUTO and can be changed by pressing the HAND/AUTO KEY. • In HAND mode the Inverter is started - the Inverter status icon starts turning. <p>Notes:</p> <p>When running in AUTO mode, HAND mode cannot be selected unless the Inverter is stopped.</p> <p>When the Inverter is running in HAND mode, the motor stops when switched to AUTO.</p>
	<p>The OFF key has the following functions:</p> <ul style="list-style-type: none"> • If pressed for longer than 3 seconds the Inverter will perform an OFF2; the motor will then coast down to a standstill. • If pressed for less than 3 seconds the following actions will be performed: <ul style="list-style-type: none"> – If in AUTO mode the screen will display an information screen stating that the command sources is AUTO and can be changed using the HAND/AUTO key. The Inverter will not be stopped. – If in HAND mode the Inverter will perform an OFF1; the motor will come to a standstill in the ramp-down time set in parameter P1121.
	<p>The ESC key has the following functions:</p> <ul style="list-style-type: none"> • If pressed for less than 3 seconds the IOP returns to the previous screen or if a value has been edited, the new value is not saved. • If pressed longer than 3 seconds the IOP returns to the status screen. <p>When using the ESC key in the parameter editing mode, no data is saved unless the OK key is pressed first.</p>
	<p>The INFO key has the following functions:</p> <ul style="list-style-type: none"> • Displays additional information for the currently selected item. • Pressing INFO again will display the previous screen.
	<p>The HAND/AUTO key switches the command source between HAND and AUTO mode.</p> <ul style="list-style-type: none"> • HAND sets the command source to the IOP. • AUTO sets the command source to an external source, for example, fieldbus.

Locking and unlocking the keypad

To lock the IOP keypad press **ESC** and **INFO** simultaneously for 3 seconds or more. To unlock the keypad press **ESC** and **INFO** simultaneously for 3 seconds or more.

IOP Handheld Kit

The IOP has no internal power source, so to increase the IOP's versatility, the hand-held device has been designed.



Figure 5-22 IOP Handheld Kit

Table 5- 4 Handheld device order information

Order number	Item quantity	Item	Remarks
6SL3255-0AA00-4HA0	1	IOP	
	1	Hand-held module	
	1	Power supply unit	
	4	Rechargeable batteries	1.2 V NiMH
	1	RS232 cable	

Note

Optical cables

The cable supplied with the IOP hand-held kit is not suitable for use with the SINAMICS G110D Inverter. The following cables can be ordered:

- USB optical cable - order number: 6SL3555-0PA00-2AA0
- RS232 optical cable - order number: 3RK1922-2BP00.

The USB optical cable is used to allow a PC to be connected to the Inverter, utilizing the optical interface on the SINAMICS G110D.

The USB optical cable cannot be used to connect the IOP Hand-held device to the SINAMICS G110D Inverter.

The RS232 optical cable is used to allow the IOP Hand-held device to be connected to the Inverter, utilizing the optical interface on the SINAMICS G110D.

Commissioning the Inverter

As previously stated, the IOP is a menu driven operator panel. By choosing the appropriate menu options the user will be guide through a series of questions, which when answered, will set the appropriate values for any parameters involving the selected function.

The basic commissioning of the Inverter is performed using the following procedure:

1. From the status screen select the Wizards menu.
2. The wizards menu will display a list of functions that can be selected.
3. Using the wheel, scroll down to the "Basic Commissioning" wizard.
4. Press the wheel to confirm selection.
5. The screen will now display the first of a series of questions.
6. Using the wheel select the required answer.
7. Push the wheel to confirm your selection.
8. The screen will then display the next question in the series.
9. Some questions require that a value be set, if the default value is not acceptable.
10. Using the wheel rotate the wheel to increase or decrease the value of the individual digits and press the wheel to move to the next digit in the sequence.
11. When all the questions have been answered, a

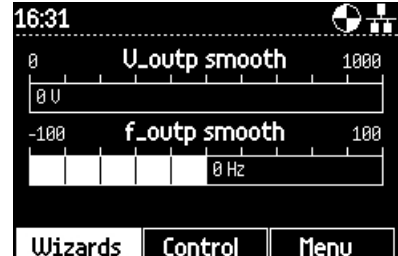

summary screen will display all the settings that have been selected.

12. If a particular settings is wrong or needs to be changed, press the ESC key to return to the previous screen and continue from that point by answering the questions again.
13. If all the settings are correct, then using the wheel scroll down and highlight "continue".
14. Press the wheel to confirm your selection.
15. The IOP will now set all the parameters to the selected values required for basic commissioning.
16. On completion of the saving process, a screen will appear to confirm the settings have been saved.
17. Pressing the wheel will return the IOP to the status screen.

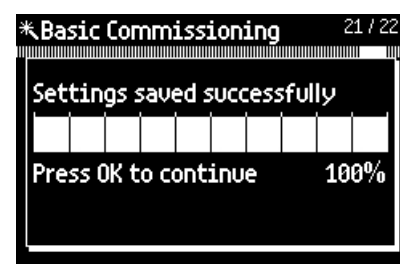
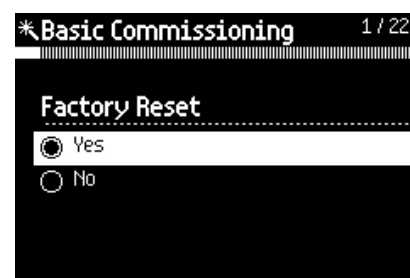

Commissioning the application

The IOP, depending upon the type of Inverter, will display a number of wizards, which will guide the user through the setting up standard applications and functions.

In the Operating Instructions of the IOP are a number of wiring diagrams associated with each application wizards. If the Inverter is wired in accordance with these diagrams, then the application can be configured using the relevant wizard.

5.8 Example application

Commissioning the applications

The following information is provided to allow a simple conveyor application to be setup. The logic and control mechanism is provided by a PLC.

The conveyor section consists of three sensors:

- A: This sensor detects the arrival of an item on the conveyor.
- B: This sensor detects the item and signals the next section to start and be ready to receive an item. This requires two speeds, one for the normal movement of the load and a faster speed for the transfer between conveyor sections.
- C: This sensor detects the load leaving the conveyor section.

The sensors are directly connected to the Inverter to allow their individual status to be sent to the controlling PLC.

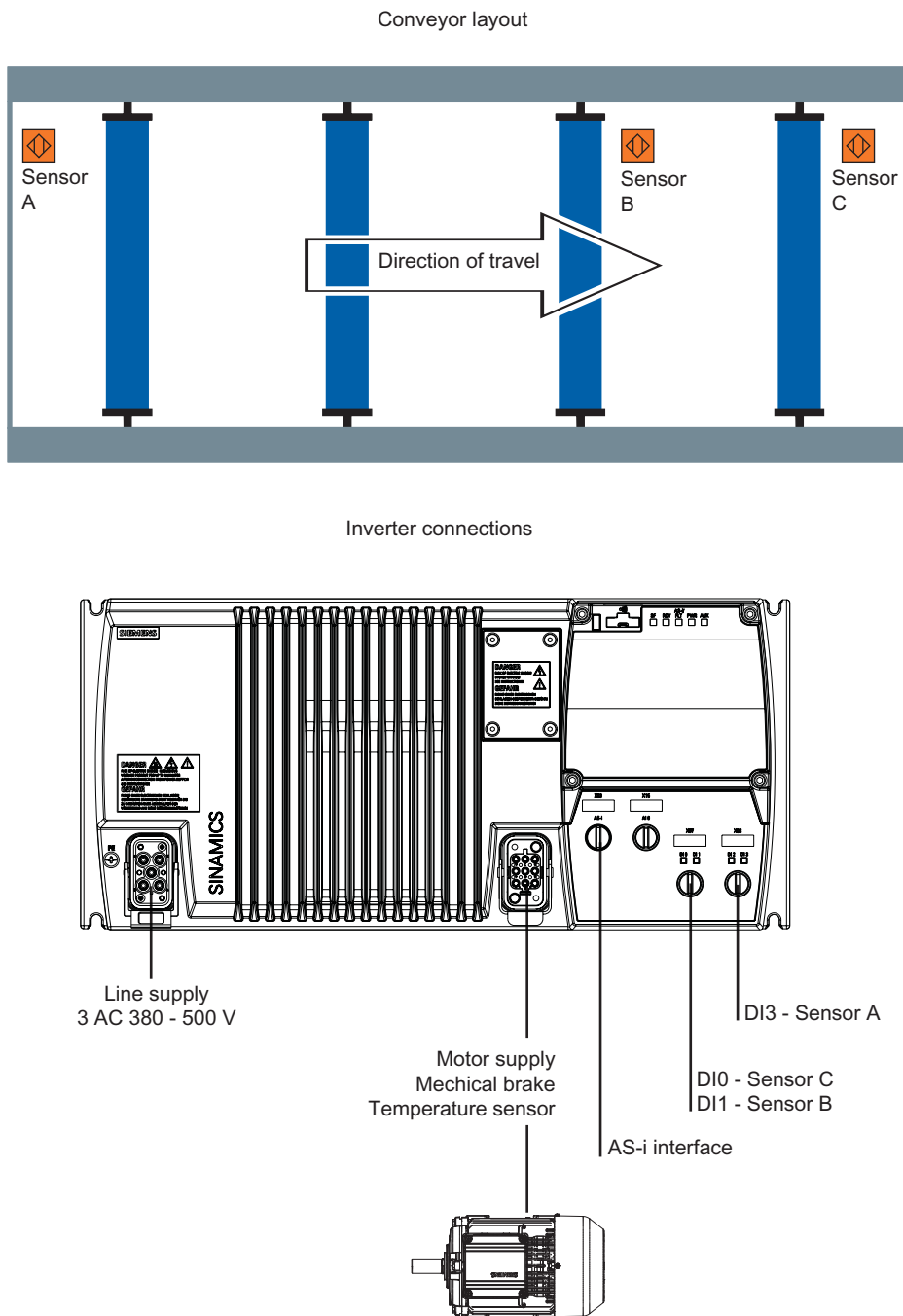

Figure 5-23 Example conveyor application

Application parameters

Using the "Expert List" mode in STARTER (as previously described) the following parameters should be modified as shown in the table below. Before setting the parameters listed below, you must wait until $P3900 = 0$.

In addition to the AS-i specific parameters discussed in the previous section the following parameters should be modified to allow the digital inputs to be read by the controlling PLC.

Table 5- 5 Conveyor application parameters

Parameter	Setting	Description
P0701 [0]	22	Digital input DI0 set to Quick Stop source 1 allowing DI0 to be used as Quick Stop input
P0971	1	Transfers parameter values from RAM to EEPROM

Example S7 script and ladder logic

The following is an example S7 script which the PLC will use to communicate with the Inverter.

Baustein:	FC2	Example application
Network:	1	Start conveyor
	U	"START"
	=	"G110D _ FAST"
Network:	2	Generate message occupied
	U	"G110D _ DI3"
	FP	"EdgeDI3"
	S	"ConveyorOccupied"
Network:	3	Switch from FAST to SLOW
	U	"G110D _ DI1"
	U	"NextConveyorOccupied"
	-	"G110D _ SLOW"
Network:	4	Wait for following conveyor
	UN	"NextConveyorOccupied"
	=	"G110D _ QSdisable"
Network:	5	Generate message occupied
	UN	"G110D _ DI0"
	FN	"EdgeDI0"
	R	"ConveyorOccupied"

Figure 5-24 Example S7 script

The following is an example ladder logic diagram.

5.8 Example application

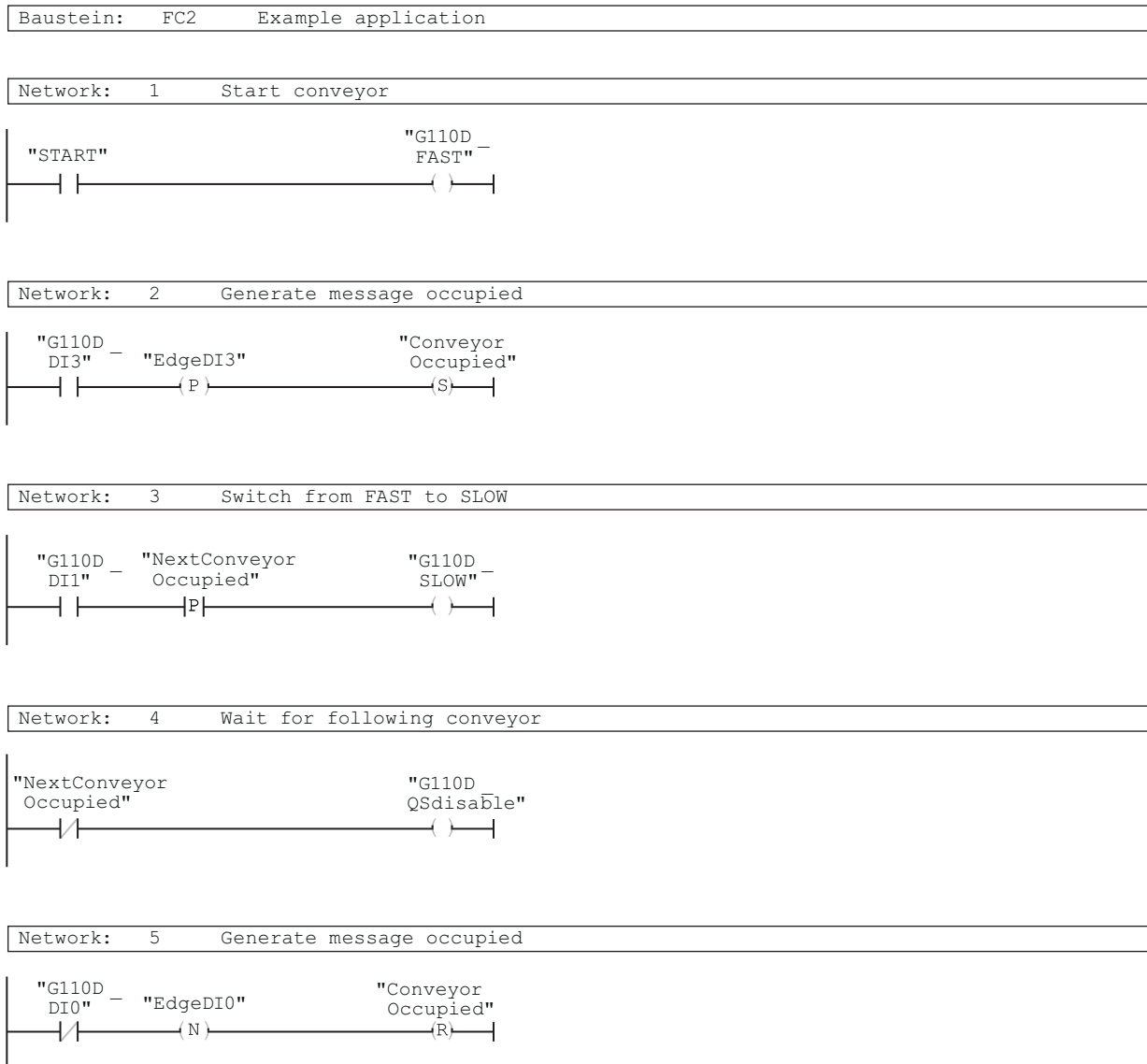

Figure 5-25 Example S7 ladder logic

5.9 Backup data and storage

5.9.1 Saving and transferring data using the IOP

The IOP as a medium to backup and transfer data

You can save a parameter set on the IOP and transfer it to other Inverters, for example, to identically parameterize several Inverters or to transfer the settings after an Inverter has been replaced.

Prerequisites for transferring data sets from the IOP to a different Inverter

The Inverter to which the parameter set is transferred must be of the same type and have the same firmware release as the source Inverter.

Saving the parameters on the IOP and Inverter

Saving the parameters on the IOP or the Inverter is accomplished easily with the menu driven structure of the IOP.

1. From the status screen select "Menu"
2. From the "Menu" screen selected "Up/Download".
3. Press the wheel to confirm the selection.
4. Select one of the following:
 - Download: Panel to drive
 - Upload: Drive to panel.
5. Press the wheel to confirm selection.
6. A scroll bar will appear showing the status of the download and the percentage completed.
7. When the download or upload has completed, a screen will be displayed stating that the download or upload has been successful or not.
8. The IOP display will return to the "Up/Download" screen.

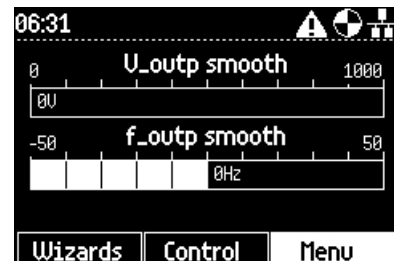

5.9.2 Saving and transferring data using the MMC

The SD/MMC memory card as a medium for backing up and transferring data

You can save a parameter set on the memory card and transfer it to other Inverters, for example, to identically parameterized Inverters or to transfer the settings after an Inverter has been replaced.

Note

Location of memory card holder

The memory card holder on the SINAMICS G110D is located under the top cover of the Control Unit housing. The memory card must be installed prior to the electrical installation of the Inverter. When re-assembling the housing, it is important to ensure that the seals are replaced correctly because if the seal are not fitted incorrectly it will adversely affect the IP rating of the Inverter.

Data backup

The SD/MMC is a removable, non-volatile flash memory for the parameter sets of an Inverter and does not require a power supply. For instance, this can be used to transfer parameter settings to a new Inverter after the previous one was replaced.

We recommend that memory card MMC (Order No.: 6SL3254-0AM00-0AA0) should be used.

Prerequisites for transferring data sets from the SD/MMC to a different inverter

The Control Unit to which the parameter set is transferred must be of the same type and have the same firmware release as the source Control Unit. (Same 'type' means: The same Order No.)

Backup the parameters on the SD/MMC memory card (upload)

Parameter	Description
Insert SD/MMC	
A0564	This alarm means that the SD/MMC was inserted while the device was in operation and that no SD/MMC was inserted when the inverter was started.
P0003 = 3	3: Access level 3
P0010 = 30	30: Parameter transfer
P0802 = 2	2: Start data transfer from the EEPROM to the SD/MMC. "RDY" LED flashes.
	<ul style="list-style-type: none"> If the upload procedure is successful, P0010 and P0802 are set to 0 and the "RDY" LED lights up. If the download procedure is unsuccessful, F0061 or F0062 is displayed and the LED "SF" (red) lights up. In this case, make another attempt to transfer data.

Note

Time it takes to save the data

It can take several minutes to transfer data to the SD/MMC memory card.

Transferring the parameters from the SD/MMC memory card into the frequency inverter (download)

Parameter	Description
P0003 = 3	3: Access level 3
P0010 = 30	30: Parameter transfer
P0803 = 2	2: Start data transfer from the SD/MMC to the EEPROM in the CU. "RDY" LED flashes.
	<ul style="list-style-type: none">• If the upload procedure is successful, P0010 and P0803 are set to 0 and the "RDY" LED lights up.• If the download procedure is unsuccessful, F0061 or F0062 is displayed and the LED "SF" (red) lights up. In this case, make another attempt to transfer data.

Functions

6.1 Overview of Inverter functions

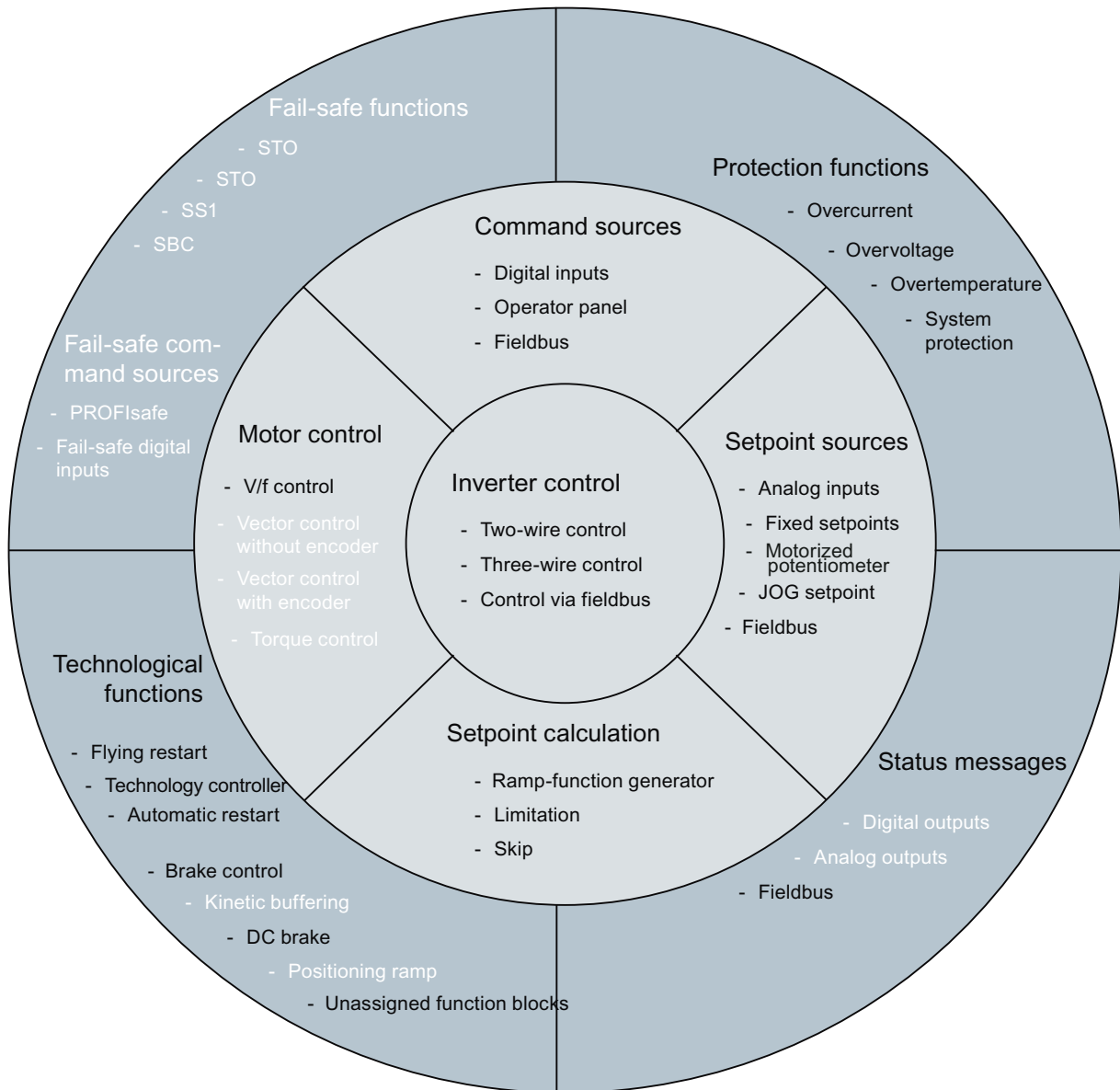

Note: The functions in white text are not relevant to the SINAMICS G110D Inverter.

Figure 6-1 Overview of Inverter functions

Functions relevant to all applications

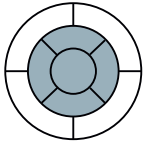

The functions that you require in each application are located at the center of the function overview above. The parameters of these functions are provided with a matching basic setting during quick commissioning so that in many cases, the motor can be operated without requiring additional parameterization.

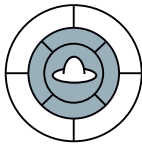

Inverter control is responsible for all of the other inverter functions. Among other things, it defines how the inverter responds to external control signals.

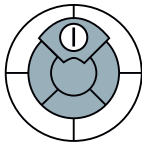

The **command source** defines from where the control signals are received to switch-on the motor, e.g. via digital inputs or a fieldbus.

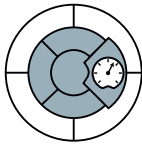

The **setpoint source** defines how the speed setpoint for the motor is entered, e.g. via an analog input or a fieldbus.

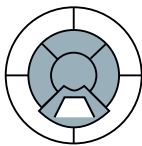

The **setpoint calculation** uses a ramp-function generator to prevent speed steps occurring and to limit the speed to a permissible maximum value.

Functions required in special applications only

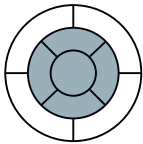

The functions, whose parameters you only have to adapt when actually required, are located at the outer edge of the function overview above.

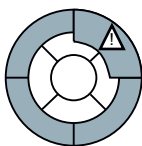

The **production functions** avoid overloads and operating states that could cause damage to the motor, inverter and driven load. The motor temperature monitoring is, e.g. set here.

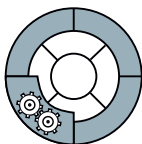

The **technological functions** allow you to activate a motor holding brake or implement a higher-level pressure or temperature control using the technology controller, for example.

Connection to a fieldbus



The SINAMICS G110D Inverter has been designed to operate on an AS-i network, therefore you must connect the following inverter functions with the fieldbus:

- Command sources
- Setpoint sources
- Status messages

A connection with a fieldbus can be established using software tools in the control systems. This manual includes descriptions of how connect and integrate the Inverter with a SIMATIC control.

6.2 Inverter Control

6.2.1 Frequency inverter control using digital inputs (two/three-wire control)

Configuring start, stop and direction of rotation reversal using digital inputs

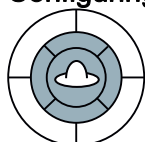

If the inverter is controlled using digital inputs, using parameter P0727, you can define how the motor responds when it is started, stopped, and the direction of rotation is changed (reversing).

Five different methods are available for controlling the motor. Three of the five control methods just require two control commands (two-wire control). The other two control methods require three control commands (three-wire control).

The wide range of setting options is especially intended to be able to emulate existing control methods on the plant or system side if the inverter has to be integrated into an existing application. The two most common methods use the factory setting (P0727 = 0) and are available as standard in SINAMICS inverters.

Note

When clockwise rotation is activated, the inverter generates a clockwise voltage characteristic at its output terminals. Whether the connected motor actually rotates clockwise depends on the wiring between the inverter and motor.

Factory setting for "start", "stop", and "direction reversal" control commands

In the factory setting (P0727 = 0), the motor is operated using two control commands. In this case, two versions are available

Further methods for "start", "stop", and "direction reversal" control commands

Parameter P0727 offers three additional methods for controlling the motor.

- Method 3 for controlling the motor is ideal for drives where the direction of rotation is manually changed, for instance, traction drives that are controlled from a master switch. It functions similarly to method 2. Method 3 differs from method 2 with respect to how the motor responds when both control commands are present at the same time, and that it also allows you to change the direction of rotation at any time.
- Two further methods are available for controlling motors, each of which use three control commands. With these methods, the motor is no longer controlled via the signal level only but also with the positive signal edges of certain commands.

Just the same as method 3 of the two-wire control, the first three-wire control method is especially suitable for drives where the direction of rotation is manually reversed.

Table 6- 1 Comparison of the methods for two-wire motor control

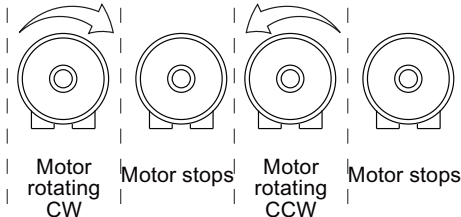
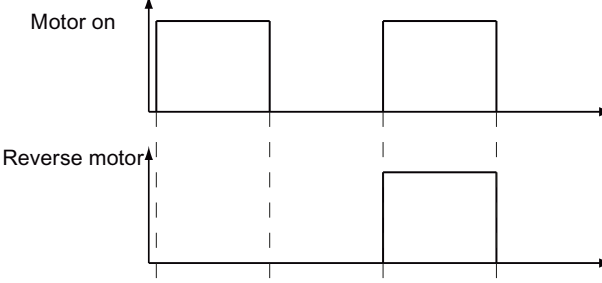
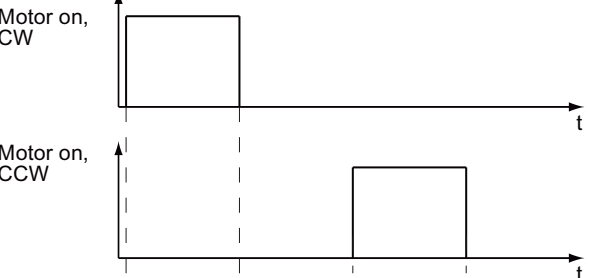
Control commands	Description
 <p>Motor rotating CW Motor stops Motor rotating CCW Motor stops</p>	
<p>Two-wire control, method 1 (P0727=0)</p> 	<p>1. Control command: Switch the motor on or off</p> <p>2. Control command: Reverses the motor direction of rotation</p>
<p>Two-wire control, method 2 (P0727=0)</p> <p>If CW and CCW rotation are selected simultaneously, the signal that was issued first has priority. The second signal is ignored. The motor cannot be reversed as long as it is still rotating.</p> 	<p>1. Control command: Switch on or switch off the motor CW rotation</p> <p>2. Control command: Switch on or switch off the motor CCW rotation</p>

<p>Control commands</p>  <p>Motor rotating CW Motor stops Motor rotating CCW Motor stops</p>	<p>Description</p>
<p>Two-wire control, method 3 (P0727=1) When CW and CCW are simultaneously selected, the motor is stopped. Reversing is possible at any time.</p>	
	<ol style="list-style-type: none"> 1. Control command: Switch on or switch off the motor CW rotation 2. Control command: Switch on or switch off the motor CCW rotation

Table 6- 2 Comparison of the methods for three-wire motor control

<p>Control commands</p>  <p>Motor rotating CW Motor stops Motor rotating CCW Motor stops</p>	<p>Explanation</p>
<p>Three-wire control, method 1 (P0727 = 2)</p>	
	<ol style="list-style-type: none"> 1. Control command: Enable the motor so that it can be switched on or switched off 2. Control command: Switch on the motor CW rotation 3. Control command: Switch on motor CCW rotation

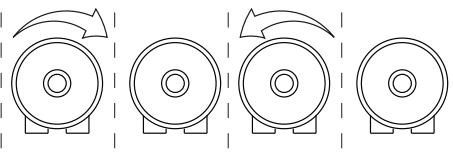
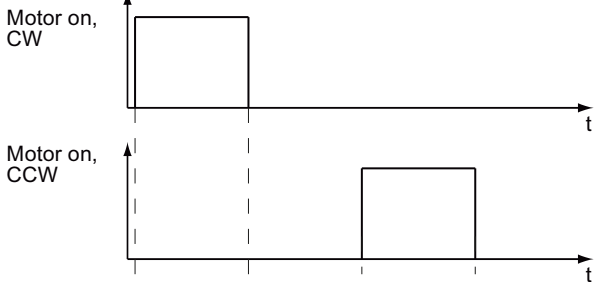
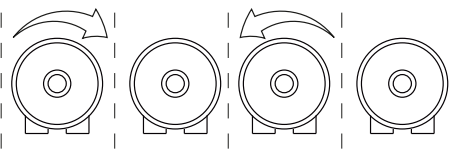
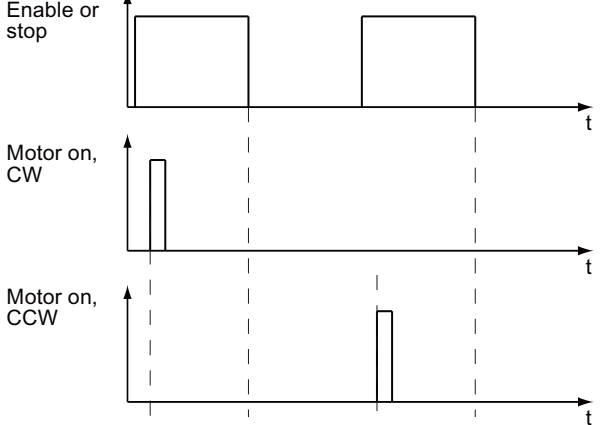
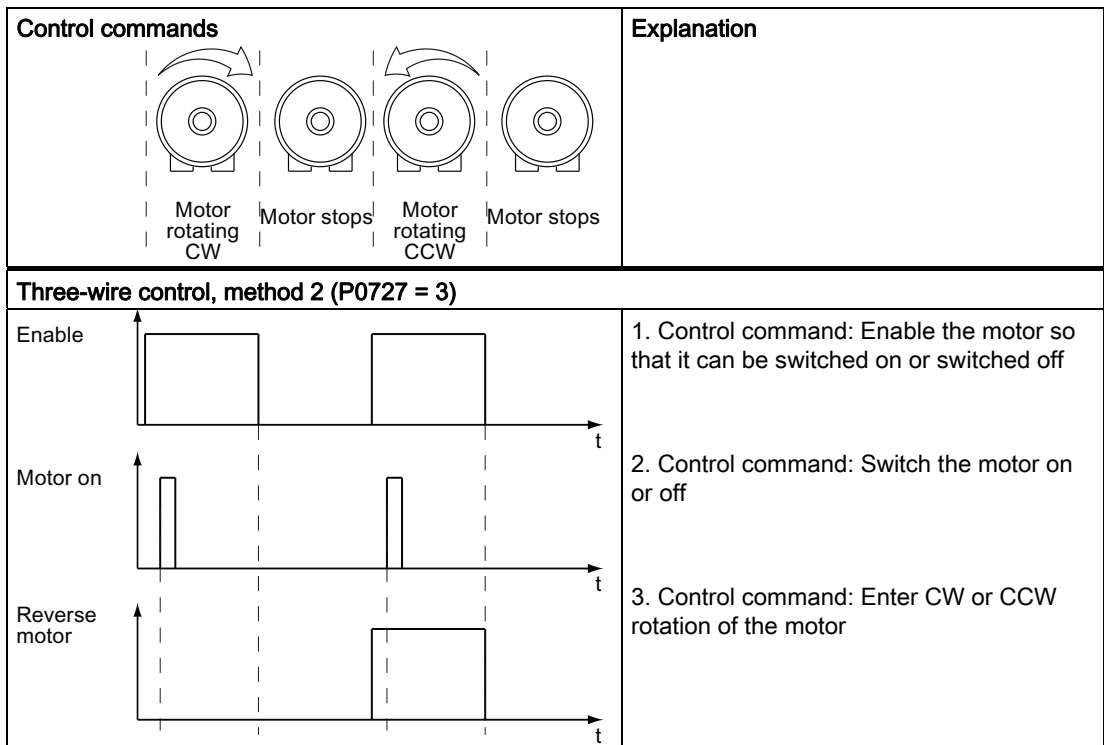

A detailed description of all of the methods to control a motor can be found in the following sections.

6.2.2 Two-wire control, method 1

Function description

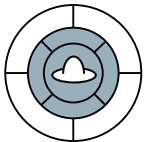

This control method uses two control commands as permanent signals.

One control command starts/stops the motor, while the other control command changes the direction of rotation.

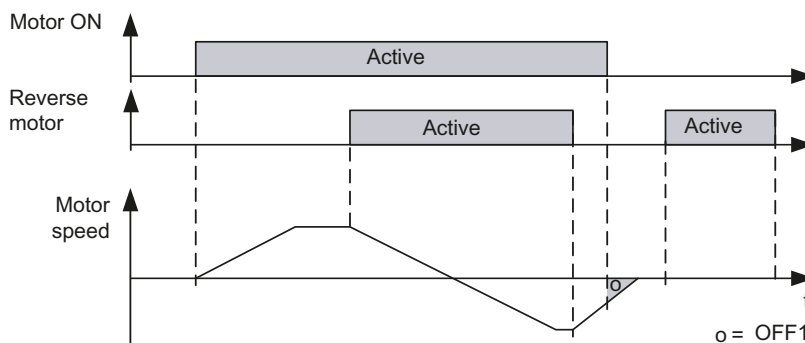

Figure 6-2 Two-wire control using digital inputs, method 1

Table 6- 3 Function table

Motor ON	Reverse motor	Function
0	0	OFF1: The motor decelerates to a standstill
0	1	OFF1: The motor decelerates to a standstill
1	0	The motor accelerates to the setpoint
1	1	The motor accelerates to the inverted setpoint

Table 6- 4 Parameterizing the function

Parameter	Description
P0700 = 2	Controls the motor using the digital inputs of the inverter
P0727 = 0	Two-wire control, method 1 or 2
P0701 = 1	The motor is power-up with digital input 0 Further options: The motor can be powered-up with any other digital input, e.g. with digital input 3 via P0704 = 1
P0702 = 12	The motor is reversed with digital input 1 Further options: The motor can be reversed with any other digital input, e.g. with digital input 3 via P0704 = 12

6.2.3 Two-wire control, method 2

Function description



This control method uses two control commands as permanent signals.

CW and CCW rotation of the motor is started and stopped with one control command each. To change the direction, the drive must first decelerate to 0 Hz with OFF1 before the direction reversal signal is accepted.

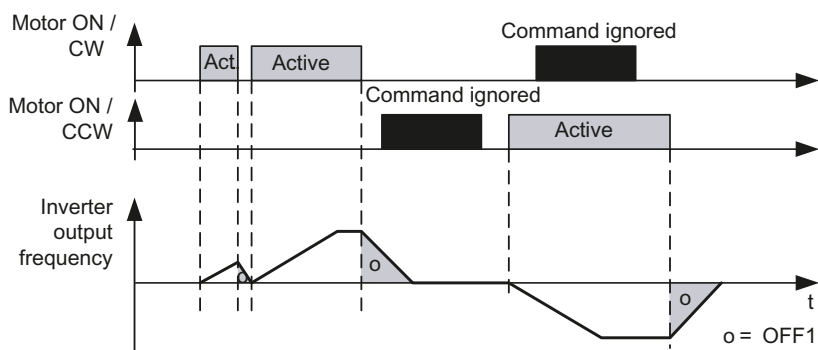

Figure 6-3 Two-wire control using digital inputs, method 2

Table 6-5 Function table

Motor ON / CW	Motor ON / CCW	Function
0	0	OFF1: The motor decelerates to a standstill
0	1	The motor accelerates to the inverted setpoint
1	0	The motor accelerates to the setpoint
1	1	The first active signal has priority; the second signal is ignored.

Table 6-6 Parameterizing the function

Parameter	Description
P0700 = 2	Controls the motor using the digital inputs of the inverter
P0727 = 0	Two-wire control, method 1 or 2
P0701 = 1	CW rotation is activated with digital input 0 Further options: CW rotation can be activated with any other digital input, e.g. with digital input 3 via P0704 = 1
P0702 = 2	CCW rotation is activated with digital input 1 Further options: CCW rotation can be activated with any other digital input, e.g. with digital input 3 via P0704 = 2

6.2.4 Two-wire control, method 3

Function description

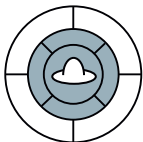

This control method uses two control commands as permanent signals.

Like method 2, CW and CCW rotation can be started/stopped by one control command each. In contrast to method 2, however, the control commands can be switched at any time regardless of the setpoint, output frequency, and direction of rotation. The motor does not have to coast to 0 Hz either before a control command is executed.

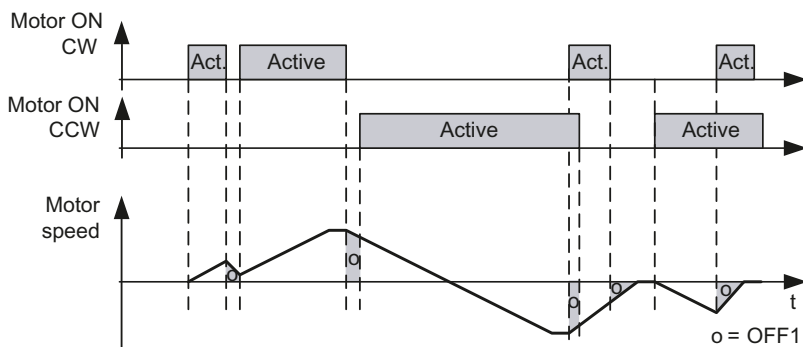

Figure 6-4 Two-wire control using digital inputs, method 3

Table 6- 7 Function table

Motor ON / CW	Motor ON / CCW	Function
0	0	OFF1: The motor decelerates to a standstill
0	1	The motor accelerates to the inverted setpoint
1	0	The motor accelerates to the setpoint
1	1	OFF1: The motor decelerates to a standstill

Table 6- 8 Parameterizing the function

Parameter	Description
P0700 = 2	Controls the motor using the digital inputs of the inverter
P0727 = 1	Two-wire control, method 3
P0701 = 1	CW rotation is activated with digital input 0 Further options: CW rotation can be activated with any other digital input, e.g. with digital input 3 via P0704 = 1
P0702 = 2	CCW rotation is activated with digital input 1 Further options: CCW rotation can be activated with any other digital input, e.g. with digital input 3 via P0704 = 2

6.2.5 Three-wire control, method 1

Function description

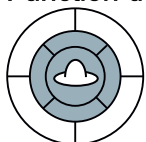

- The first control command is a permanent enable signal for starting the motor. When this enable signal is canceled, the motor stops.
- CW rotation is activated with the positive edge of the second control command.
- CCW rotation is activated with the positive edge of the third control command.

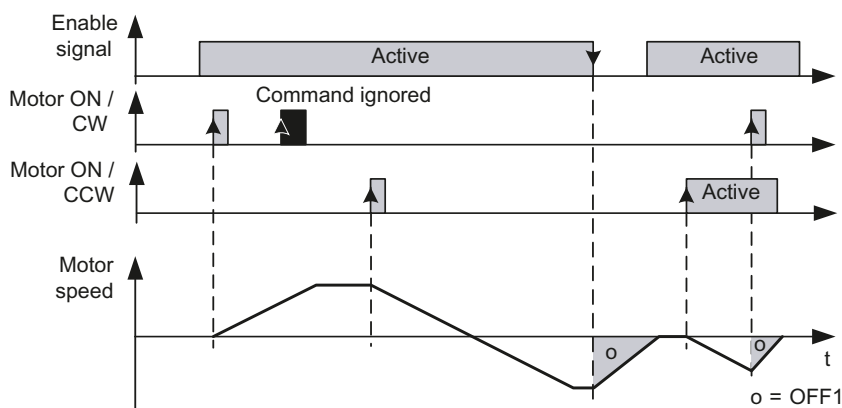

Figure 6-5 Three-wire control using digital inputs, method 1

Table 6- 9 Function table

Enable signal	Motor ON / CW	Motor ON / CCW	Function
0	Not relevant	Not relevant	OFF1: The motor decelerates to a standstill
1	0→1	0	The motor accelerates to the setpoint
1	0	0→1	The motor accelerates to the inverted setpoint
1	0	0	No effect on the direction of rotation.
1	1	1	OFF1: The motor decelerates to a standstill

Table 6- 10 Parameterizing the function

Parameter	Description
P0700 = 2	Controls the motor using the digital inputs of the inverter
P0727 = 2	Three-wire control, method 1
P0701 = 1	The enable signal to power-up the motor is issued with digital input 0 Further options: The enable signal can be issued with any other digital input, e.g. with digital input 3 via P0704 = 1
P0702 = 2	CW rotation is activated with digital input 1 Further options: CW rotation can be activated with any other digital input, e.g. with digital input 3 via P0704 = 2
P0703 = 12	CCW rotation is activated with digital input 2 Further options: CCW rotation can be activated with any other digital input, e.g. with digital input 3 via P0704 = 12

6.2.6 Three-wire control, method 2

Function description

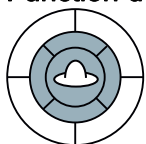

- The first control command is a permanent enable signal for starting the motor. When this enable signal is canceled, the motor stops.
- The motor is started with the positive edge of the second control command.
- The third control command defines the direction of rotation.

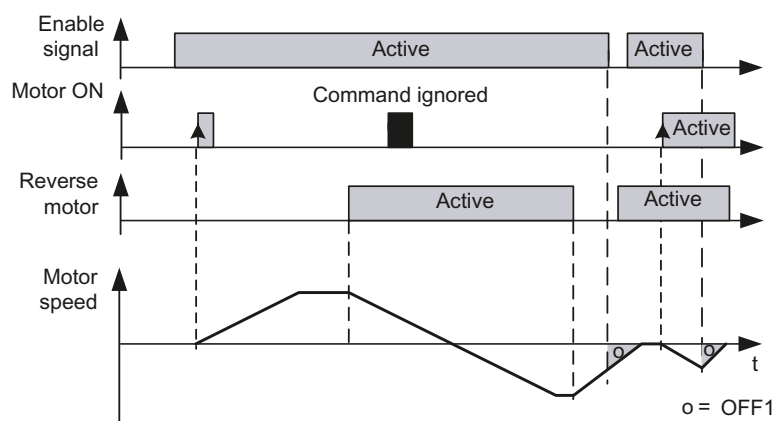

Figure 6-6 Three-wire control using digital inputs, method 2

Table 6- 11 Function table

Enable signal	Motor ON	Reverse motor	Function when motor is at a standstill	Function when motor is rotating
0	Not relevant	Not relevant	No effect	OFF1: The motor decelerates to a standstill
1	0→1	0	The motor accelerates to the setpoint	No effect
1	0→1	1	The motor accelerates to the inverted setpoint	No effect
1	0	1→0	No effect	The motor reverses to the setpoint.
1	0	0→1	No effect	The motor reverses to the inverted setpoint.

Table 6- 12 Parameterizing the function

Parameter	Description
P0700 = 2	Controls the motor using the digital inputs of the inverter
P0727 = 3	Three-wire control, method 2
P0701 = 2	The enable signal to power-up the motor is issued with digital input 0 Further options: The enable signal can be issued with any other digital input, e.g. with digital input 3 via P0704 = 2
P0702 = 1	The motor is started with digital input 1 Further options: The motor can be started with any other digital input, e.g. with digital input 3 via P0704 = 1
P0703 = 12	The direction of the motor is reversed with digital input 2 Further options: The direction of the motor can be reversed with any other digital input, e.g. with digital input 3 via P0704 = 12

6.3 Command sources

6.3.1 Selecting command sources

Selecting the command source [P0700]

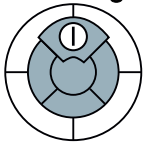

The motor is switched on/off via external inverter control commands. The following command sources can be used to specify these control commands:

- Operator Panel - automatically handled when HAND mode is selected
- Digital inputs
- Fieldbus

The command sources available depend on the inverter version.

- For inverters with a fieldbus interface, the 'fieldbus' (P0700 = 6) is pre-selected as the command source,

Table 6- 13 Parameters, to select the source for the inverter control commands

Parameters	Description
P0700 = ...	0: Factory default setting 2: Digital inputs (P0701 ... P0705) 4: USS at RS 232 6: Fieldbus (P2050 ... P02091) default setting.

6.3.2 Assigning functions to digital inputs

Assigning control commands to digital inputs as command sources [P0701...P0704]

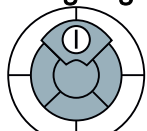

The digital inputs are pre-assigned with certain control commands in the factory. However, these digital inputs can be freely assigned to a control command.

Table 6- 14 Factory setting of the digital inputs

Digital input no.	Control command
Digital input 0 (DI0)	Switch motor on/off (ON/OFF1)
Digital input 1 (DI1)	Reverse direction of rotation
Digital input 2 (DI2)	Fault acknowledgment
Digital input 3 (DI3)	Selects fixed frequency 1

Table 6- 15 Changing the digital input settings

Digital input no.	Parameter	Description
	P0003 = 2	Extended access to the parameters
Digital input 0 (DI0)	P0701 = ...	Possible values for P0701 to P0704: 0: Digital input disabled 1: ON/OFF1 2: ON reverse /OFF1 3: OFF2 - coast to standstill 4: OFF3 - quick ramp-down 9: Fault acknowledge 10: JOG right 11: JOG left 12: Reverse 13: MOP up (increase frequency) 14: MOP down (decrease frequency) 15: Fixed frequency selector bit0 16: Fixed frequency selector bit1 17: Fixed frequency selector bit2 18: Fixed frequency selector bit3 22: QuickStop Source 1 23: QuickStop Source 2 24: QuickStop Override 25: DC brake enable 27: Enable PID 29: External trip 33: Disable additional freq setpoint 99: Enable BICO parameterization
Digital input 1 (DI1)	P0702 = ...	
Digital input 2 (DI2)	P0703 = ...	
Digital input 3 (DI3)	P0704 = ...	

If you enable one of the digital inputs to be freely used for BICO technology (P701...P704 = 99), then you must interconnect this digital input to the required control command.

If value 99 is assigned to the digital input to define its function, this can only be reversed by restoring the factory setting.

6.3.3 Controlling the motor using the fieldbus

Control commands using the fieldbus

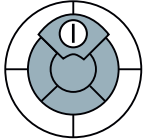

To control the motor using the fieldbus, the inverter must be connected to a higher-level control using the STARTER software tool. For more information, see Chapter "Operation in fieldbus systems".

6.4 Setpoint sources

6.4.1 Selecting the setpoint source [P1000]

Selecting the setpoint source [P1000]

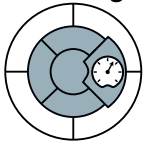

The speed of the motor can be set using the frequency setpoint. The following sources can be used to specify the frequency setpoint:

- Analog inputs
- Fixed frequency using digital inputs (default setting)
- Motorized potentiometer
- Fieldbuses

Table 6- 16 Settings to select the possible frequency setpoint sources

Parameter	Description
P0003 = 1	Standard: Access to the most frequently used parameters
P1000 = ...	0: No main setpoint 1: MOP setpoint / motorized potentiometer 2: Analog setpoint 3: Fixed frequency (default setting) 4: USS on RS 232 6: Fieldbus

Adding setpoints from different sources

You can add several setpoints using frequency setpoint source P1000. For more information, see the List Manual (P1000 in the parameter list and function diagram 5000).

6.4.2 Frequency setpoint using analog input [P1000=2]

Frequency setpoint using analog input [for P1000 = 2]

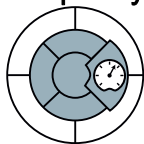

Analog setpoints are read-in using the analog input. The setting specifying whether the analog input is a voltage input (10 V) or voltage input (10 V) with monitoring must be made using P0756.

Depending on the AI type of the source, a suitable connection must be established.

Table 6- 17 Set and parameterize the analog input for use as setpoint source

Analog input	Parameters	Description
	Setting the DIP switch	
AI0+	P0756 [0]	Analog input 0
AI0-		
	P0756 = 0	Analog input type (AI) Defines the analog input type and enables analog input monitoring. 0: Unipolar voltage input (0 ... +10 V) (factory setting) 1: Unipolar voltage input with monitoring (0 ... +10 V)
	P0757 = 0	Value x1 for AI scaling [V or mA]
	P0758 = 0.0	Value y1 of AI-scaling This parameter shows the amount of x1 as a % of P2000 (reference frequency)
	P0761 = 0	Width of the AI dead zone

6.4.3 Using a motorized potentiometer as a setpoint source

Frequency setpoint using motorized potentiometer (MOP) (when P1000 = 1 -> P1031)

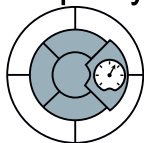

The 'motorized potentiometer' function simulates an electromechanical potentiometer for entering setpoints. The value of the motorized potentiometer (MOP) can be set by means of the "up" and "down" control commands.

Table 6- 18 Example: Implementing the motorized potentiometer using the Operator Panel keys

Parameter	Description
P1000 = 1	1: MOP setpoint
P1031 = 0	Setpoint memory of the MOP The last motorized potentiometer setpoint that was active prior to the OFF command or shutdown can be saved. 0: MOP setpoint is not saved (factory setting) 1: MOP setpoint is saved in P1040

Parameter	Description
P1032 = 1	Disable opposite direction of the MOP 0: Reverse direction of rotation is permitted 1: Reverse direction of rotation is locked (factory setting)
P1040 = 5	Setpoint of the MOP Determines the setpoint [Hz] of the motorized potentiometer (MOP). Factory setting 5 Hz
P2000 = 50	Reference frequency (Hz); An output value of the MOP of 100 % corresponds to the frequency setpoint from P2000. P2000 should be changed, if a maximum frequency greater than 50 Hz is required.

Table 6- 19 Example: Implementing a motorized potentiometer using digital inputs

Parameters	Description
P0700 = 2	2: Digital inputs P0701...P0704 (DI x ON/OFF1; DI y "up" and DI z "down")
P0701 = 1	1: ON/OFF1
P0702 = 13	13: MOP "up"
P0703 = 14	14: MOP "down"
P1000 = 1	1: MOP setpoint
P1031 = 0	Setpoint memory of the MOP The last motorized potentiometer setpoint that was active prior to the OFF command or shutdown can be saved. 0: MOP setpoint is not saved (factory setting) 1: MOP setpoint is saved in P1040
P1032 = 1	Disable opposite direction of the MOP 0: Reverse direction of rotation is permitted 1: Reverse direction of rotation is locked (factory setting)
P1040 = 5	Setpoint of the MOP Determines the setpoint [Hz] of the motorized potentiometer (MOP); factory setting, 5 Hz
P2000 = 50	Reference frequency (Hz); An output value of the MOP of 100 % corresponds to the frequency setpoint from P2000. P2000 should be changed, if a maximum frequency greater than 50 Hz is required.

6.4.4 Using fixed frequencies as a setpoint source

Frequency setpoint via fixed frequency (P1000 = 3)

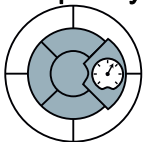

The fixed frequencies are defined using parameters P1001 to P1004 and can be assigned to the corresponding digital inputs using P1020 to P1023.

The fixed frequency can be selected using digital input 3 by default. However, the assignment of fixed frequencies can be configured to use any of the other digital inputs on the Inverter. An example is given below of selecting two fixed frequencies using digital input 2 and 3.

Table 6- 20 Parameters to directly select frequencies

Parameters	Description
P1016 = 1	Fixed frequency mode, defines the procedure for selecting fixed frequencies. 1: Direct selection (factory setting) 2: Binary-coded selection
P1001 = 50	Fixed frequency 1 (FF1) (FF values in Hz)
P1002 = -50	Fixed frequency 2 (FF2)
P1003 = 10	Fixed frequency 3 (FF3)
P1004 = 15	Fixed frequency 4 (FF4)
P1020 = 2091.0	FF1 selection using fieldbus

Additional information about binary coded selection of the fixed frequencies (P1016 = 2) is provided in function chart 3210 of the List Manual.

Table 6- 21 Example: Selecting 2 fixed frequencies using digital input 2 and digital input 3

Parameter	Description
P0003 = 3	Enable expert access to parameters
P0700 = 2	Selecting the command source: Digital inputs
P0701 = 1	ON/OFF1 (DI0) - factory setting
P0702 = 12	Direction reversal (DI1) - factory setting
P0703 = 99	Enable / 'open' digital input 2 (DI2)
P0704 = 99	Enable / 'open' digital input 3 (DI3)
P1001 = 4.00	Defines fixed frequency 1 (FF1) in [Hz]
P1002 = 8.00	Defines fixed frequency 2 (FF2) in [Hz]
P1020 = 2091.0	Connect fixed frequency 1(FF1) with the status of DI2. 2091.0 = Parameter, which displays the status of digital input 2.
P1021 = 2091.1	Connect fixed frequency 2(FF2) with the status of DI3. 2091.1 = Parameter, which displays the status of digital input 3.

6.4.5 Running the motor in jog mode (JOG function)

Run motor in jog mode [JOG function]

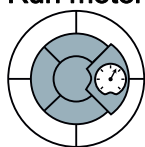

The JOG function enables you to carry out the following:

- Test the motor and inverter after commissioning to ensure that they function properly (the first traverse movement, direction of rotation etc.)
- Move a motor or motor load to a specific position
- Run a motor (e.g. following program interruption)

This function allows the motor to start up or rotate with a specific jog frequency. This function can normally be activated via the JOG button on the Basic Operator Panel,

When this function is enabled, the motor starts up ("ready for operation" status) when the JOG button is pressed and rotates at the set JOG frequency. When the button is released, the motor stops. This button has no effect when the motor is already running.

Table 6-22 Example: Enabling the jog mode

Parameters	Description
P0003 = 2	2: Extended
P1057 = 1	JOG enable 0: JOG function locked 1: JOG function enabled (factory setting)
P1058 = 5	JOG frequency CW 0 Hz ... 650 Hz in JOG mode of motor in clockwise direction of rotation; 5 Hz (factory setting)
P1059 = 5	JOG frequency CCW 0 Hz ... 650 Hz in the motor JOG mode in the counter-clockwise direction; 5 Hz (factory setting)
P1060 = 10	JOG ramp-up time 0 s ... 650 s / 10 s (factory setting) Ramp-up time (in seconds) from 0 to maximum frequency (P1082). The ramp-up procedure in JOG mode is limited by P1058 or P1059.
P1061 = 10	JOG ramp-down time 0 s ... 650 s / 10 s (factory setting) The ramp-down time in seconds from the highest frequency (P1082) to 0.

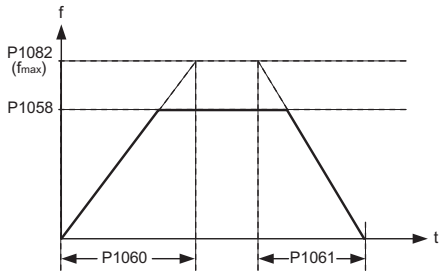

Using BICO technology, you can also assign the JOG function to other keys.

Table 6-23 Parameter to assign the JOG function to another button

Parameters	Description
P0003 = 3	3: Expert
P1055 = ...	Enable JOG CW Possible sources: 722.x (digital inputs) / 19.8 (JOG key on the Operator Panel) / r2090.8 (serial interface)
P1056 = ...	Enable JOG CCW Possible sources: 722.x (digital inputs) / 19.8 (JOG key on the Operator Panel) / r2090.9 (serial interface)

6.4.6 Specifying the motor speed via the fieldbus

Specifying the motor speed via the fieldbus

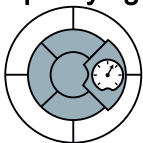

To specify the speed of the motor via the fieldbus, the inverter must be connected to a higher-level control via the STARTER software tool. For more information, see "Operation in fieldbus systems".

6.5 Changing over the command data sets (manual, automatic)

Switching operating priority

In some applications, the inverter is operated from different locations.

Example: Switchover from the automatic mode into the manual mode

A central control can switch a motor on/off or change its speed either via a fieldbus or via local switches. A key-operated switch close to the motor can be used to switch the operating priority of the inverter from "control via fieldbus" to "local control".

Command data set (CDS)

The inverter offers options to parameterize the settings for the command sources, setpoint sources and status messages (with the exception of analog outputs) in three different ways. The associated parameters are indexed (index 0, 1 or 2). When the inverter is operational, control commands select one of the three indices and therefore one of the three settings that has been saved. This means that as described in the example above, the master control of the inverter can be switched over.

All of the switchable parameters for command sources, setpoint sources and status messages with the same index is known as a "command data set".

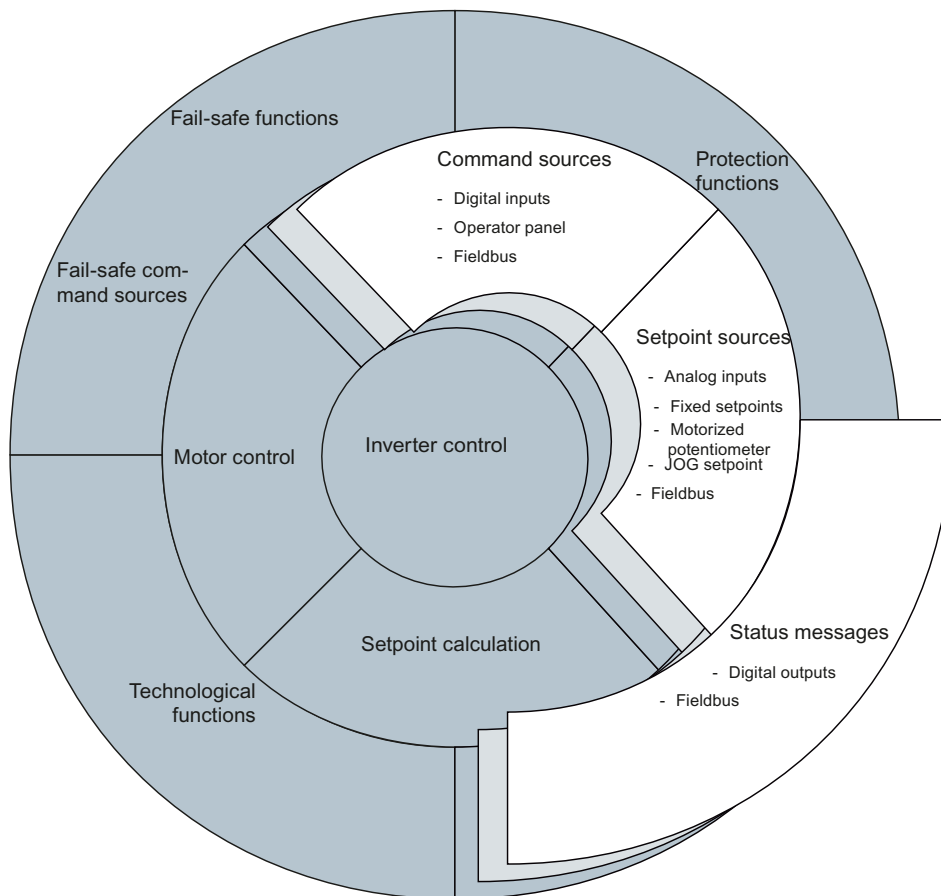
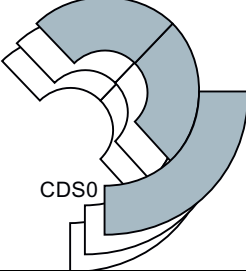
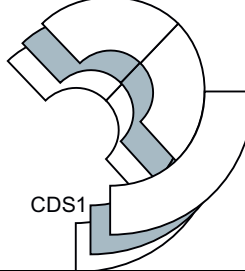
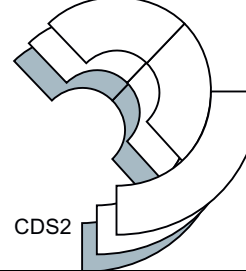

Figure 6-7 CDS switchover in the inverter

6.5 Changing over the command data sets (manual, automatic)

The command data sets are switched over using parameters P0810 and P0811. Parameters P0810 and P0811 are interlinked to control commands, e.g. the digital inputs of the inverter, using BICO technology.

Table 6- 24 Command data set changeover using parameters P0810 and P0811.

Status of P0810	0	1	0 or 1
Status of P0811	0	0	1
The CDS that is current active is gray.			
Selected parameter index	0	1	2
Examples	Fieldbus as setpoint source: The speed setpoint is specified via the fieldbus.	Analog input as setpoint source: The speed setpoint is specified via an analog input.	-
	Fieldbus as command source: The motor is switched on/off via the fieldbus.	Digital inputs as command source: The motor is switched on/off via digital inputs.	-

Note

Command data sets can be switched in the "ready for operation" and "operation" state. The switchover time is approx. 4 ms.

Table 6- 25 Parameters for switching the command data sets:

Parameter	Description
P0810 = ...	1st control command for switching the command data sets Example: When P0810 = 722.0, the system switches from command data set 0 to command data set 1 via digital input 0.
P0811 = ...	2nd control command for switching the command data sets
r0050	Displaying the number of the CDS that is currently active
A copy function is available making it easier to commission more than one command data set:	
P0809.0 = ...	Number of the command data set to be copied (source)
P0809.1 = ...	Number of the command data set to which the data is to be copied (target)
P0809.2 = 1	Start copying

For an overview of all the parameters that belong to the drive data sets and can be switched, see the List Manual.

6.6 Setpoint preparation

6.6.1 Overview of setpoint preparation

Overview of setpoint calculation

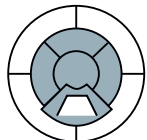

The setpoint calculation modifies the speed setpoint, e.g. it limits the setpoint to a maximum and minimum value and using the ramp-function generator prevents the motor from executing speed steps.

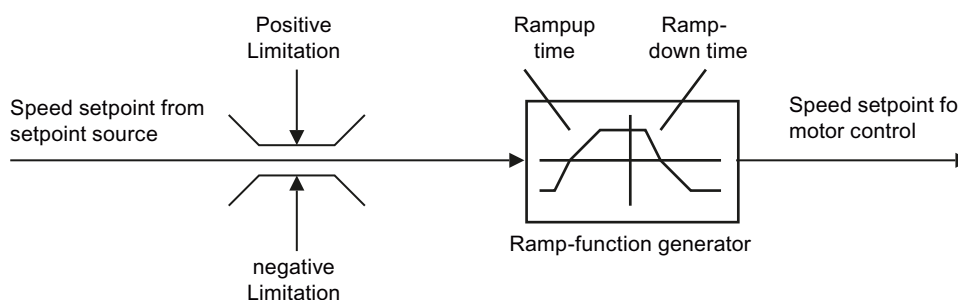

Figure 6-8 Setpoint calculation in the inverter

6.6.2 Minimum frequency and maximum frequency

Limiting the speed setpoint



The speed setpoint is limited by both the minimum and maximum frequency.

Minimum frequency

When the motor is switched on, it accelerates to the minimum frequency regardless of the frequency setpoint. The set parameter value applies to both directions of rotation. In addition to its limiting role, the minimum frequency can be used as a reference value for various monitoring functions (e.g. if a motor holding brake is engaged when the minimum frequency is reached).

Maximum frequency

The frequency setpoint is limited to the maximum frequency in both directions of rotation. A message is output if the maximum frequency is exceeded.

The maximum frequency also acts as an important reference value for various inverter functions (e.g. the ramp-function generator).

Table 6- 26 Parameters for minimum and maximum frequency

Parameter	Description
P1080 = ...	Minimum frequency
P1082 = ...	Maximum frequency

6.6.3 Parameterizing the ramp-function generator

Parameterizing the ramp-function generator

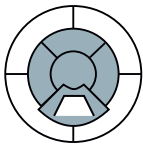

The ramp-function generator in the setpoint channel limits the speed of setpoint changes. This causes the motor to accelerate and decelerate more smoothly, thereby protecting the mechanical components of the driven machine.

Ramp-up/down time

The ramp-up and ramp-down times of the ramp-function generator can be set independently of each other. The times that you select depend purely on the application in question and can range from just a few 100 ms (e.g. for belt conveyor drives) to several minutes (e.g. for centrifuges).

When the motor is switched on/off via ON/OFF1, the motor also accelerates/decelerates in accordance with the times set in the ramp-function generator.

Table 6- 27 Parameters for ramp-up time and ramp-down time

Parameters	Description	
P1120 = ...	Ramp-up time Duration of acceleration (in seconds) from zero speed to the maximum frequency (P1082).	
P1121 = ...	Ramp-down time Duration of deceleration (in seconds) from the maximum frequency (P1082) to standstill.	

The quick-stop function (OFF3) has a separate ramp-down time, which is set with P1135.

Note

If the ramp-up/down times are too short, the motor accelerates/decelerates with the maximum possible torque and the set times will be exceeded.

Rounding

Acceleration can be "smoothed" further by means of rounding. The jerk occurring when the motor starts and when it begins to decelerate can be reduced independently of each other. Rounding can be used to lengthen the motor acceleration/deceleration times. The ramp-up/down time parameterized in the ramp-function generator is exceeded.

Rounding does not affect the ramp-down time in the event of a quick stop (OFF3).

Table 6- 28 Rounding parameters

Parameter	Description
P1130 = ...	Initial rounding time for ramp up (in seconds)
P1131 = ...	Final rounding time for ramp up (in seconds)
P1132 = ...	Initial rounding time for ramp down (in seconds)
P1133 = ...	Final rounding time for ramp down (in seconds)
P1134 = ...	Rounding type

For more information about this function, see the List Manual (function diagram 5300 and the parameter list).

6.7 Motor control

6.7.1 V/f control with linear characteristics

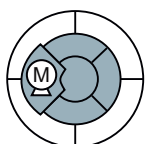

Table 6- 29 Setting the control type

Parameter	Description
P0003 = 2	Extended access
P1300 = 0	Control type: V/f control with linear characteristic

Optimizing the starting characteristics for a high break loose torque and brief overload

The inverter can provide a higher voltage in the lower speed range and when accelerating. Examples of applications where this is necessary, include:

- Utilizing the brief overload capability of the motor when accelerating
- Driven machines with a high breakaway torque
- Holding a load

Background information: The linear characteristic of the V/f control assumes an ideal motor without resistive losses. The resistive losses in the motor stator resistance and in the motor cable reduce the available torque and must not be neglected in all applications. These losses play a more significant role the smaller the motor and the lower the motor speed. The losses can be compensated by the V/f control by increasing the voltage at low speeds. (so-called 'boost parameters': P1310 and P1311)

Note

Only increase the voltage boost in small steps until satisfactory motor behavior is reached. Excessively high values in P1310 and P1311 can cause the motor to overheat and switch off (trip) the inverter due to overcurrent .

Table 6- 30 Optimizing the starting characteristics for a linear characteristic

Parameters	Description
P0003 = 2	Extended access
P1310 = ...	<p>Continuous Boost Defines boost level in [%] relative to P0305 (rated motor current) applicable to both linear and quadratic V/f curves. At low output frequencies the output voltage is low to keep the flux level constant. However, the output voltage may be too low for the following:</p> <ul style="list-style-type: none"> • magnetisation the asynchronous motor • hold the load • overcome losses in the system. <p>The inverter output voltage can be increased via P1310 for the compensation of losses, hold loads at 0 Hz or maintain the magnetization. The magnitude of the boost in Volt at a frequency of zero is defined as follows: $V_ConBoost, 100 = \sqrt{3} * P0305 * P0350 * (P1310/100)$</p> <p>Increasing the boost levels increases motor heating (especially at standstill). Setting in P0640 (motor overload factor [%]) limits the boost: $sum(V_Boost) / (P0305 * P0350) \leq P1310 / 100$</p> <p>The boost values are combined when continuous boost (P1310) used in conjunction with other boost parameters (acceleration boost P1311 and starting boost P1312). However priorities are allocated to these parameters as follows: $P1310 > P1311 > P1312$</p> <p>The total boost is limited by following equation: $sum(V_Boost) \leq 1.3 * \sqrt{3} * P0305 * P0350 * (P0640/100)$</p>
P1311 = ...	<p>Acceleration boost Applies boost in [%] relative to P0305 (rated motor current) following a positive setpoint change and drops back out once the setpoint is reached. P1311 will only produce boost during ramping, and is therefore useful for additional torque during acceleration and deceleration. As opposed to parameter P1312, which is only active on the first acceleration issued after the ON command, parameter P1311 is always effect during an acceleration and deceleration when issued. The magnitude of the boost in Volt at a frequency of zero is defined as follows: $V_AccBoost, 100 = \sqrt{3} * P0305 * P0350 * (P1311/100)$</p>
P1312 = ...	<p>Starting Boost Applies a constant linear offset (in [%] relative to P0305 (rated motor current)) to active V/f curve (either linear or quadratic) after an ON command and is active until:</p> <ol style="list-style-type: none"> 1. ramp output reaches setpoint for the first time respectively 2. setpoint is reduced to less than present ramp output <p>This is useful for starting loads with high inertia. Setting the starting boost (P1312) too high will cause the inverter to limit the current, which will in turn restrict the output frequency to below the setpoint frequency. The magnitude of the boost in Volt at a frequency of zero is defined as follows: $V_StartBoost, 100 = \sqrt{3} * P0305 * P0350 * (P1312/100)$</p>

Additional information about this function is provided in the parameter list and in the function diagram 6100 in the List Manual.

6.7.2 V/f control with parabolic characteristic

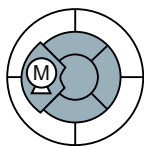

Note

V/f control with a parabolic characteristic must not be used in applications in which a high torque is required at low speeds.

Table 6- 31 Setting the control type

Parameter	Description
P0003 = 2	Extended access
P1300 = 2	Control type: V/f control with parabolic characteristic

6.7.3 Typical applications for V/f control

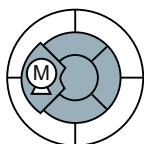

V/f control is perfectly suitable for almost any application in which the speed of induction motors is to be changed. Examples of typical applications for V/f control include:

- Pumps
- Fans
- Compressors
- Horizontal conveyors

Basic properties of V/f control

V/f control sets the voltage at the motor terminals on the basis of the specified speed setpoint. The relationship between the speed setpoint and stator voltage is calculated using characteristic curves. The inverter provides the two most important characteristics (linear and square-law). User-defined characteristic curves are also supported.

V/f control is not a high-precision method of controlling the speed of the motor. The speed setpoint and the speed of the motor shaft are always slightly different. The deviation depends on the motor load. If the connected motor is loaded with the rated torque, the motor speed is below the speed setpoint by the amount of the rated slip. If the load is driving the motor (i.e. the motor is operating as a generator), the motor speed is above the speed setpoint.

6.7.4 Additional characteristics of the V/f control

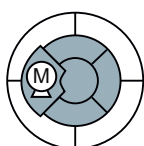

In addition to linear and square-law characteristics, there are the following additional versions of the V/f control that are suitable for special applications.

Table 6- 32 Further V/f control methods (P1300)

Parameter value	Application
P1300 = 1	Linear V/f characteristic with Flux Current Control (FCC) Voltage losses across the stator resistance are automatically compensated. This is particularly useful for small motors since they have a relatively high stator resistance. The prerequisite is that the value of the stator resistance in P350 is parameterized as accurately as possible.
P1300 = 3	Freely adjustable V/f characteristic, which supports the torque behavior of synchronous motors (SIEMOSYN motors)
P1300 = 5 P1300 = 6	Linear V/f characteristic for textile applications where it is important that the motor speed is kept constant under all circumstances. This setting has the following effects: <ol style="list-style-type: none"> 1. When the maximum current limit is reached, the stator voltage is reduced but not the speed. 2. Slip compensation is locked.
P1300 = 19	V/f control without characteristic. The interrelationship between the frequency and voltage is not calculated in the inverter, but is specified by the user. With BICO technology, P1330 defines the interface via which the voltage setpoint is entered (e.g. analog input → P1330 = 755).

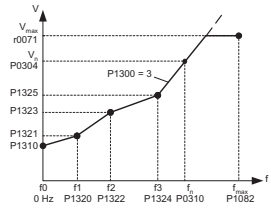

For more information about this function, see function diagram 6100 in the List Manual.

6.8 Protection functions

6.8.1 Protective functions of the frequency inverter

The frequency inverter offers protective functions against overtemperature and overcurrent for both the frequency inverter as well as the motor. Further, the frequency inverter protects itself against an excessively high DC link voltage when the motor is regenerating.

The load torque monitoring functions provide effective plant and system protection.

6.8.2 Overtemperature protection for the Inverter

Temperature monitoring for the inverter

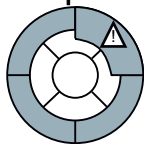

Parameter s	Description
P0003 = 3	User access level 3: Expert

Parameters	Description
P0290 = 2	<p>Temperature monitoring of the Inverter Selects reaction of inverter to an internal thermal overload condition.</p> <p>0: Reduce output frequency and output current 1: No reduction, trip (F0004/ 5/ 6) when thermal limits reached 2: Reduce pulse frequency, output current and output frequency 3: Reduce pulse freq. only and trip (F0006) when overload too high</p> <p>The following physical values influence the inverter overload protection (see diagram):</p> <ul style="list-style-type: none"> Heat sink temperature (r0037[0]); causes A0504 and F0004. IGBT Junction temperature (r0037[1]); causes F0004 or F0006. Delta temperature between heat sink and junction temperature; causes A0504 and F0006. Inverter I²t (r0036); causes A0505 and F0005. <div style="text-align: center;"> </div> <p>P0290 = 0, 2:</p> <ul style="list-style-type: none"> Reduction of output frequency is only effective if the load is also reduced. This is for example valid for light overload applications with a quadratic torque characteristic as pumps or fans. For settings P0290 = 0 or 2, the I-max controller will act upon the output current limit (r0067) in case of overtemperature. <p>P0290 = 0:</p> <ul style="list-style-type: none"> With pulse frequencies above nominal, pulse frequency will be reduced to nominal immediately in the event of r0027 greater than r0067 (current limit). <p>P0290 = 2, 3:</p> <ul style="list-style-type: none"> The pulse frequency P1800 is reduced only if higher than 2 kHz and if the operating frequency is below 2 Hz. The actual pulse frequency is displayed in parameter r1801[0] and the minimal pulse frequency for reduction is displayed in r1801[1]. Inverter I²t acts upon output current and output frequency, but not on pulse frequency. <p>A trip will always result, if the action taken does not sufficiently reduce internal temperatures.</p>
P0292	Parameterizes the alarm threshold for heatsink and module temperature monitoring

Temperature monitoring for the motor

The implementation of thermal protection for the motor is accomplished using the following types of thermal sensors:

- PTC sensor
- KTY 84 sensor
- ThermoClick sensor

Temperature sensing using a temperature sensor

Table 6- 33 Parameters to sense the temperature using a temperature sensor

Parameters	Description
P0003 = 2	User access level 2: Extended
P0335 = 0	Specify the motor cooling 0: Self-ventilated* - with fan on the motor shaft (IC410* or IC411*) - (factory setting) 1: Forced ventilation* - with a separately driven fan (IC416*) 2: Self-ventilated* and inner cooling* (open-circuit air cooled) 3: Forced ventilated* and inner cooling* (open-circuit air cooled)
P0601 = 0	Specify the motor temperature sensor 0: No sensor (factory setting; → P0610) 1: PTC thermistor (→ P0604) 2: KTY84 (→ P0604) 4: ThermoClick sensor
P0604 = ...	Motor overtemperature alarm threshold (0°C ... 220°C, factory setting 130°C) Enter the alarm threshold for motor overtemperature protection. The shutdown temperature threshold (alarm threshold + 10 %) is the value at which either the inverter is shut down or I _{max} is reduced (P0610).
P0610 = 2	<i>This parameter is only visible, if P0003 = 3!</i> Response for motor overtemperature I²t Defines the behavior as soon as the motor temperature reaches the alarm threshold. 0: No response, alarm only 1: Alarm and reduction of I _{max} (reduces the output frequency) 2: Fault and shutdown (F0011) (factory setting)
P0640	Motor overload factor (entered in % referred to P0305: rated motor current)

*You will find detailed information on classifying the cooling technique in EN 60034-6

6.8.3 Overcurrent protection

Method of operation

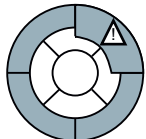

The maximum current controller (I_{max} controller) protects the motor and inverter against overload by limiting the output current. The I_{max} controller is only active with V/f control.

If an overload situation occurs, the speed and stator voltage of the motor are reduced until the current is within the permissible range. If the motor is in regenerative mode, i.e. it is being driven by the connected machine, the I_{max} controller increases the speed and stator voltage of the motor to reduce the current.

Note

The inverter load is only reduced if the frequency is reduced with a lower load and at lower speeds (e.g. parabolic torque-speed characteristic of the motor load).

In the regenerative mode, the current only decreases if the torque decreases at a higher frequency.

Settings

NOTICE
The factory setting of the I_{max} controller only needs to be changed in exceptional cases by appropriately trained personnel.

Table 6- 34 I_{max} controller parameters

Parameter	Description
P0003 = 3	User access level 3: Expert
P0305 = ...	Rated motor current
P0640 = ...	Maximum permissible motor overload referred to P0305 rated motor current
P1340 = ...	Proportional gain of controller for frequency reduction
P1341 = ...	Integral time of controller for frequency reduction
P1345 = ...	Proportional gain of controller for voltage reduction
P1346 = ...	Integral time of controller for voltage reduction
r0056 bit13	Status: I_{max} controller active
r1343	Frequency output of I_{max} controller Shows the amount to which the I-max controller reduces the inverter output frequency.
r1344	Voltage output of I_{max} controller Shows the amount by which the I-max controller reduces the inverter output voltage.

For more information about this function, see function diagram 6100 in the List Manual.

6.8.4 Limiting the maximum DC link voltage

How does the motor generate overvoltage?

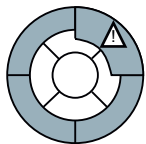

An induction motor can operate as a generator if it is driven by the connected load. In this case, the motor converts mechanical energy into electrical energy. The motor feeds the regenerative energy back to the inverter.

As a consequence, the DC link voltage is increased. The inverter can only reduce the increased DC link voltage if it is capable of regenerative feedback into the line supply or is equipped with a braking resistor.

Without being capable of regenerating into the line supply, only extremely low or brief regenerative loads – relative to the inverter power – are possible because the inverter may be damaged if the DC link voltage reaches critical levels. Before the voltage can reach critical levels, however, the inverter shuts down with the fault message "DC link overvoltage". When the V_{DCmax} controller is enabled, it is imperative that the user ensures that the Inverter reaction to DC link overvoltage is within acceptable limits for their specific application.

Protecting the motor and inverter against overvoltage

The V_{DCmax} controller prevents – as far as is technically possible – the DC link voltage from reaching critical levels.

The V_{DCmax} controller is not suitable for applications in which the motor is permanently in the regenerative mode, e.g. in hoisting gear or when large flywheel masses are subject to braking. For applications such as these, you must select an inverter that is equipped with a braking resistor or that can feed energy back into the line supply.

Table 6- 35 V_{DCmax} controller parameters

Parameter	Description
P0003 = 3	User access level 3: Expert
P1240 = ...	Enables the V_{DCmax} controller 0: disables V_{DCmax} Controller (default setting) 1: Enables the V_{DCmax} Controller
r1242	Shows the value of the DC link voltage above which the V_{DCmax} controller is active
P1243 = ...	Multiplier for the output of V_{DCmax} controller (scaling of the V_{DCmax} controller output)
P1250 = ...	Proportional gain of the V_{DCmax} controller
P1251 = ...	Integral time of the V_{DCmax} controller
P1252 = ...	Derivative time of the V_{DCmax} controller
P1253 = ...	Limits the output of the V_{DCmax} controller
P1254 = ...	Activates or deactivates automatic detection of the switch-on levels of the V_{DCmax} controller

For more information about this function, see function diagram 4600 in the List Manual.

6.8.5 Load torque monitoring (system protection)

Applications with load torque monitoring

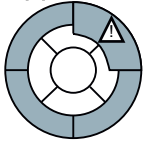

In many applications, it is advisable to monitor the motor torque:

- Applications in which the mechanical connection between the motor and load may be interrupted (e.g. if the drive belt in fan or conveyor belt systems tears).
- Applications that are to be protected against overload or locking (e.g. extruders or mixers).
- Applications in which no-load operation of the motor represents a critical situation (e.g. pumps).

Load torque monitoring functions

The inverter monitors the torque of the motor in different ways:

1. No-load monitoring:
The inverter generates a message if the motor torque is too low.
2. Lock protection:
The inverter generates a message if the motor speed cannot match the speed setpoint despite maximum torque.
3. Stall protection:
The inverter generates a message if the inverter control has lost the orientation of the motor.
4. Frequency-dependent torque monitoring:
The inverter measures the current torque and compares it with a parameterized frequency/torque characteristic.

Table 6- 36 Parameterizing the monitoring functions

Parameter	Description
No-load monitoring	
P2179 = ...	Current limit for no-load detection If the inverter current is below this value, the message "no load" is output.
P2180 = ...	Delay time for the "no load" message
Lock protection	
P2177 = ...	Delay time for the "motor locked" message
Stall protection	
P2178 = ...	Delay time for the "motor stalled" message
Frequency-dependent torque monitoring	

P2181 = ...	Enable signal for function
P2182 = ...	Frequency threshold 1
P2183 = ...	Frequency threshold 2
P2184 = ...	Frequency threshold 3
P2185 = ...	Upper torque threshold for frequency threshold 1

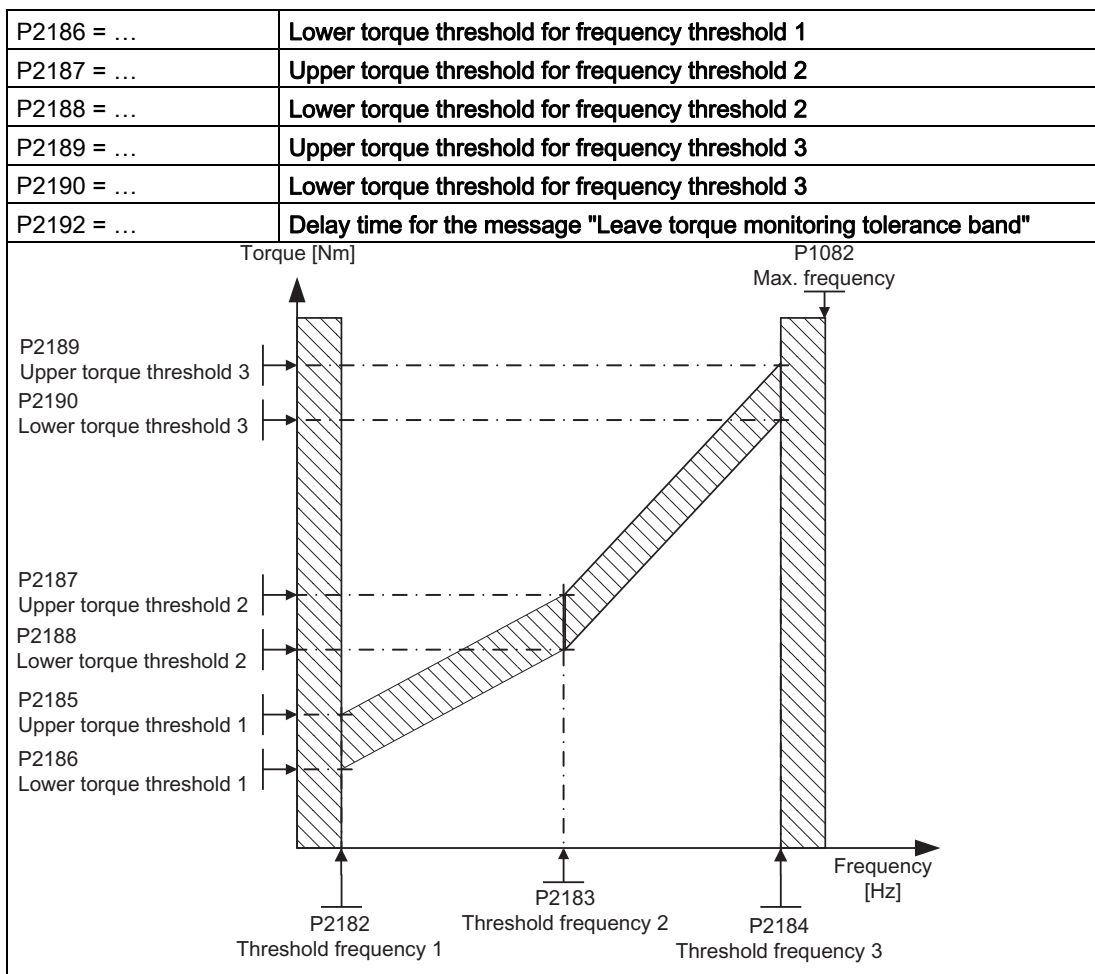

For more information about these functions, see the List Manual (function diagrams 4110, 4130, and 4140 as well as the parameter list).

6.9 Technological functions

6.9.1 Technological functions

The inverter offers the following technological functions:

- Braking functions
- Automatic restart and flying restart
- Basic process control functions
- Logical and arithmetic functions using function blocks that can be freely interconnected

Please refer to the following sections for detailed descriptions.

6.9.2 Braking functions

6.9.2.1 Braking functions of the Inverter

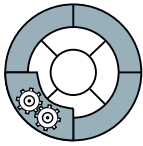

A differentiation is made between electrically braking and mechanically braking a motor:

- The motor is electrically braked by the inverter. An electrical braking is completely wear-free. Generally, a motor is switched off at standstill in order to save energy and so that the motor temperature is not unnecessarily increased.
- Mechanical brakes are generally motor holding brakes that are closed when the motor is at a standstill. Mechanical operating brakes, that are closed while the motor is rotating are subject to a high wear and are therefore often only used as an emergency brake.

Electrical braking and regenerative energy

- If an induction motor electrically brakes the connected load and the kinetic energy that is released exceeds the mechanical and electrical losses, then it operates as a generator. In this case, the motor converts kinetic energy into electrical energy.
- Regenerative braking is not available on the SINAMICS G110D Inverter.

Inverter braking methods

Depending on the particular application and the inverter type, there are different technologies to handle regenerative energy.

- The regenerative energy is converted into heat in the motor (DC braking)
- The inverter converts the regenerative energy to heat using a braking resistor (dynamic braking)

Different electrical braking methods for different applications

Table 6- 37 Braking methods depending on the application

Application examples	Electrical braking method
Pumps, fans, compressors, extruders, mixers	Not necessary
Fans, grinding machines, conveyor belts	DC braking
Centrifuges, conveyors, hoisting gear, cranes, winders	Dynamic braking

Advantages and disadvantages of the braking methods

- DC braking
 - *Advantage:* The motor is braked without the inverter having to convert the braking energy
 - *Disadvantages:* significant increase in the motor temperature; no defined braking characteristics; no constant braking torque; no braking torque at standstill; braking energy is lost as heat; does not function when the power fails.
- Dynamic braking
 - *Advantages:* defined braking characteristics; no additional motor temperature increase; constant braking torque; in principle, also functions when the power fails
 - *Disadvantages:* A braking resistor is required; braking energy is lost as heat; the permissible load of the braking resistor must be taken into account.

6.9.2.2 DC braking

Application areas for DC braking

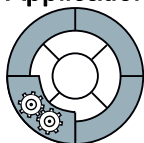

DC braking is typically used for applications in which the motor is normally operated at a constant speed and is only braked down to standstill in longer time intervals, e.g. centrifuges, saws, grinding machines and conveyor belts.

Operating characteristics of DC braking

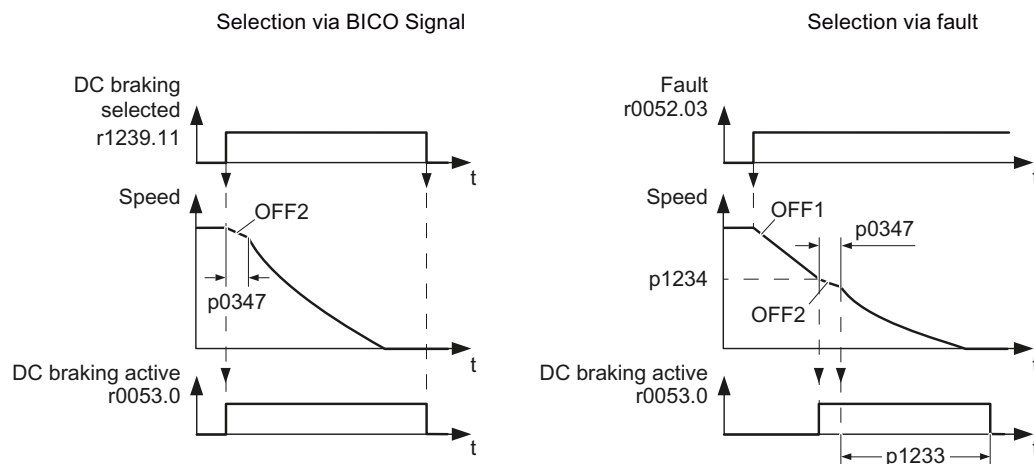



Figure 6-9 DC braking after an OFF1 or OFF3 command

DC braking after an OFF1 or OFF3 command has the following timing sequence:

1. Initially, the motor speed is reduced along the down ramp of the ramp-function generator until an adjustable speed threshold is reached.
2. Once the motor speed reaches this threshold, the inverter interrupts the braking operation using an internal OFF2 command until the motor is de-magnetized.
3. The inverter then starts the actual DC braking by allowing a DC current to flow through the motor. The magnitude and duration of the DC current can be set.

 CAUTION
<p>For DC braking, the kinetic energy of the motor and motor load is partially converted into thermal energy. The motor can overheat if braking lasts too long or the drive must be braked too frequently.</p>

Parameterizing DC braking

Table 6- 38 Parameters to enable and set DC braking

Parameter s	Description
P003= 3	User access level 3: Expert
P1230	Enabling DC braking using an external command Enables DC braking via a signal that was used by an external source (BICO). The function remains active as long as the external signal is active.
P1232=	Current, DC braking (entered as a %) Defines the strength of the direct current in [%] with respect to the rated motor current (P0305)
P1233=	Enable and duration of the DC braking for OFF1 or OFF3 command (entered in s) Defines the duration of the DC braking in seconds after an OFF1 or OFF3 command. P1233 = 0 deactivates DC braking for an OFF1 and OFF3 command.
P1234=	Starting frequency of DC braking (entered in Hz) Sets the speed threshold for the start of DC braking.
P0347=	Demagnetizing time of the motor The inverter calculates this value from the motor data during commissioning. Only commissioning engineers, who have the appropriate experience, may change the parameter values. The inverter can trip due to an overcurrent during DC braking if the demagnetizing time is too short.

DC braking using an external command

This allows DC braking to be activated using a signal from an external source (BICO). The function remains active as long as the external signal is active. The use of this function is explained in the sequence below.

1. The function is enabled and selected using BICO parameter P1230 (see figure below).
2. The Inverter pulses are inhibited for the duration of the de-magnetizing time P0347.

3. The requested braking current P1232 is impressed as long as the DC braking is enabled (P1230=1) and the motor is braked. This state is displayed using signal r0053 bit 00.
4. After the DC braking has been cancelled, the motor accelerates back to the setpoint frequency until the motor speed matches the Inverter output frequency.
5. If any faults occur during P1230=1, the DC current is set to zero. The motor does not ramp-up even if the fault is acknowledged; a new ON command is necessary.
6. If the DC brake is enabled again, the braking current P1232 is impressed as long as P1230=1.

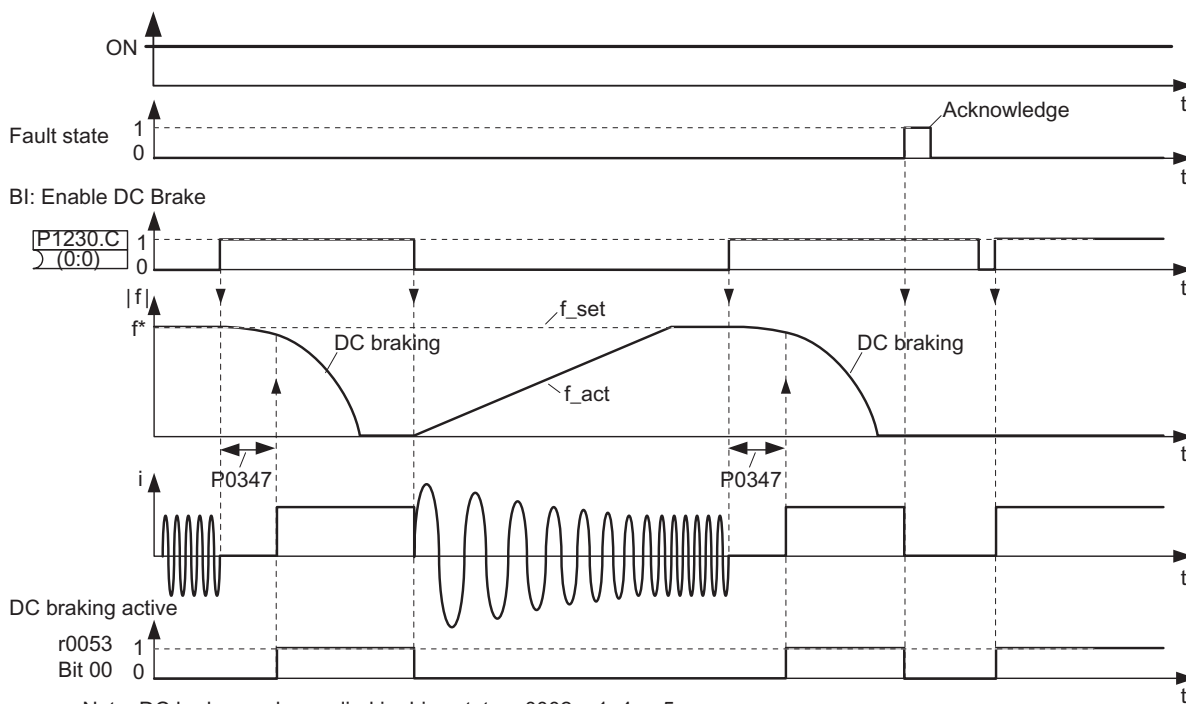

Note: DC brake can be applied in drive states r0002 = 1, 4 or 5.

Figure 6-10 DC braking using external selection

6.9.2.3 Dynamic braking

Dynamic braking applications

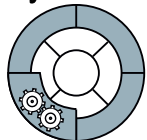

Dynamic braking is typically used in applications in which dynamic motor behavior is required at different speeds or continuous direction changes, e.g. for conveyor drives or hoisting gear.

An internal chopper control (braking chopper) in the inverter, which can control an external braking resistor, is required for dynamic braking.

Operating characteristics of dynamic braking

Dynamic braking converts the regenerative energy, which is released when the motor brakes, into heat.

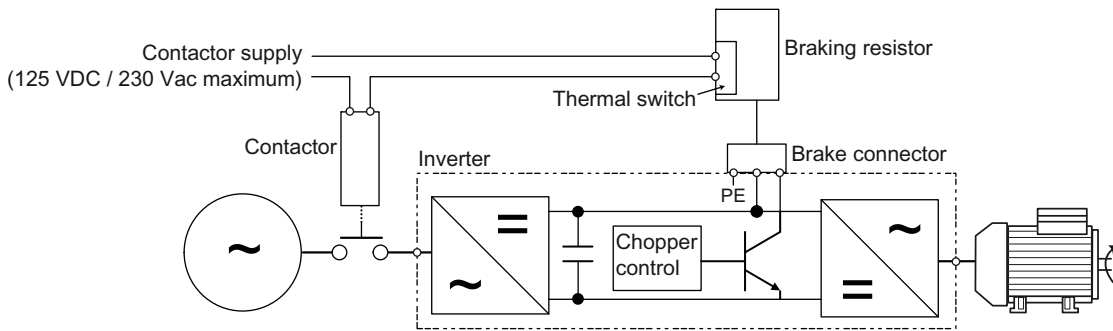

Applies to braking resistors with the following order numbers:

- 6SL3501-0BE08-6AA0
- 6SL3501-0BE12-1AA0
- 6SL3501-0BE14-1AA0

Figure 6-11 Braking chopper in the Inverter

The inverter controls the dynamic braking depending on the DC link voltage.

The temperature monitoring of the braking resistor should be evaluated. The inverter must be switched off if the braking resistor overheats.

! WARNING

If a braking resistor that is unsuitable is used, a fire could break out and severely damage the inverter.

The temperature of braking resistors increases during operation. For this reason, avoid coming into direct contact with braking resistors. Make sure that the devices are located at sufficient distances from each other and that proper ventilation is provided.

Parameterizing the dynamic braking

Table 6- 39 Parameters to enable and set dynamic braking

Parameter	Description
P0003 = 2	Extended access
P1240 = 0	Deactivate the V_{DCmax} controller
P1237	<p>Enable signal and ON period of dynamic braking</p> <p>0: Dynamic braking is locked 1: 5% ON period** 2: 10% ON period 3: 20% ON period 4: 50% ON period 5: 100% ON period</p> <p>The ON period set here is only effective if the braking resistor has reached its operating temperature. When required, a cold braking resistor is switched-in independent of this parameter</p> <p>***) SIEMENS resistors are designed for 5% ON period</p>

6.9.2.4 Parameterizing a motor holding brake

Motor holding brake applications

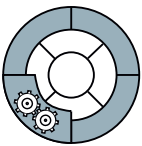

The motor holding brake prevents the motor turning when the inverter is switched-off. The inverter has internal logic to control a motor holding brake.

The motor holding brake control inside the inverter is suitable for the following typical applications:

- Pumps
- Fans
- Horizontal and vertical conveyors

Operating characteristics of the motor holding brake control after an OFF1 and OFF3 command

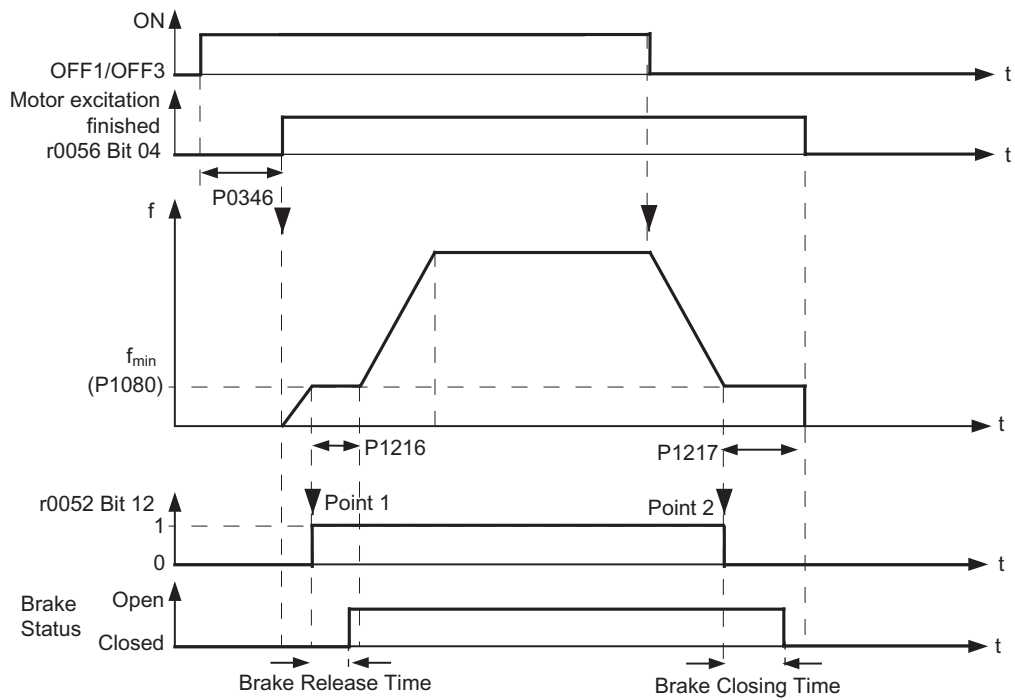

Figure 6-12 Function diagram of the motor holding brake control after an OFF1 or OFF3 command

Controlling the motor holding brake after an OFF2

For the OFF2 command the brake closing time is not taken into account.

After these control commands, the signal to close the motor holding brake is immediately output independent of the motor speed.

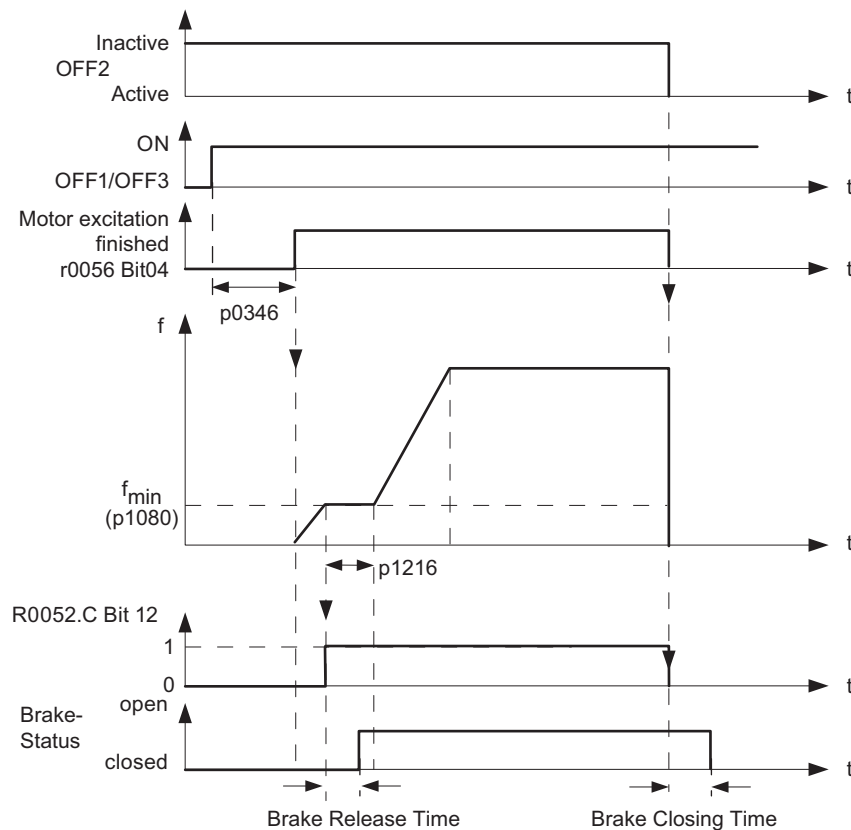

Figure 6-13 Function diagram, motor holding brake after an OFF2 command

Commissioning the control logic of a motor holding brake

WARNING

The following applications require special settings of the motor holding brake. In these cases, the motor holding brake control may only be commissioned by experienced personnel:

- All applications that involve moving and transporting people
- Hoisting gear
- Elevators
- Cranes

1. Before commissioning, secure any dangerous loads (e.g. loads on inclined conveyor belts)
2. Suppress the motor holding brake control, e.g. by disconnecting the control cables
3. When opening the motor holding brake, ensure that a torque is established that prevents the load from briefly dropping.
 - Check the magnetizing time P0346; the magnetizing time is pre-assigned when commissioning the system and must be greater than zero
 - For V/f operation (P1300 = 0 to 3), set the boost parameters P1310, P1311.

4. Parameterize the opening and closing times of the motor holding brake
 It is extremely important that electromechanical braking is controlled with the correct timing (brake release time, brake closing time, release time) to protect the brakes against long-term damage. The exact values can be found in the technical data of the connected brake. Typical values:
 - Brake release times are between 35 ms and 500 ms
 - Brake closing times are between 15 ms and 300 ms
5. Restore the motor holding brake control
 - The mechanical brake on the motor is connected to the Inverter through the motor connector.
 - To activate the motor holding brake, parameter P1215 must be set to 1.

When a motor with a built-in holding brake is commissioned, a "clicking" sound in the motor indicates that the brake has been properly released.

Table 6- 40 Control logic parameters of the motor holding brake

Parameters	Description
P0003 = 2	Enables extended parameter access
P1215 = ...	Enable motor holding brake 0 Motor holding brake locked (factory setting) 1 Motor holding brake enabled 2 Motor holding brake with voltage boost enabled
P0346 = ...	Magnetizing time time 0 ... 20 s, factory setting 1 s
P1080 = ...	Minimum frequency 0 ... 650 Hz, (0 Hz factory setting): minimum motor frequency, regardless of frequency setpoint
P1216 = ...	Delay time for opening the brake 0 ... 20 s, factory setting 0.1 s Note: P1216> brake release time + relay opening time
P1217 = ...	Holding time after runout 0 ... 20 s, factory setting 0.1 s Note: P1217> brake closing time + relay closing time
P1227 = ...	Zero value detection monitoring time 0 ... 300 s, factory setting 4 s
r0052.12	"Brake active" status

Opening the motor holding brake via P1218

Using parameter P1218, you can force the brake to open, e.g. in order to be able to manually move a conveyor drive.

 WARNING
<p>Secure loads held by the brake!</p> <p>Since this procedure cancels the "Brake active" signal which, in turn, causes the brake to be forced open, the user must ensure that, even when the motor has been powered-down, all loads held by the brake are secured before the signal is canceled.</p>

Table 6- 41 Parameter to force open a motor holding brake

Parameter	Description
P0003 = 3	Enable expert access to parameters
P1218 = 1	Forcibly open the motor holding brake

6.9.3 Automatic restart and flying restart

6.9.3.1 Automatic restart

Restart after a power failure and/or faults within a few seconds

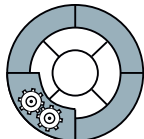

The automatic restart function is primarily used when the inverter is operated as a stand-alone device.

The "automatic restart" function is used to restart the drive automatically once the power has been restored following a power failure. All faults are acknowledged automatically and the drive is switched on again.

Line undervoltage or power failure

The power supply for the Control Unit (electronics) of the SINAMICS G110D Inverter is provided by the 24 V supply of the AS-i network.

The term "line undervoltage" describes a situation in which the line voltage fails momentarily and is then restored. The power supply of the motor is interrupted, but the AS-i network power supply is still maintained.

The term "power failure" describes a situation in which the power fails for a longer period and the AS-i network power supply is interrupted.

Important secondary condition

An ON command must be present prior to the power failure and when the power returns the presence of the previous ON command is detected and the "automatic restart" function will ensure that the Inverter runs the motor.

It is recommended that a digital input is used as the ON command source.

 WARNING
Automatic restart mode (P1210=6) If parameter P1210 is set to 6, then the Inverter will react to an ON command after a power failure by clearing all faults and alarms then running the motor. If the Inverter has been powered-down normally and P1210=6, then when the Inverter is powered-up, it will clear all faults and alarms, then start running the motor automatically.

Since the function is not restricted to line supply faults, it can also be used to automatically acknowledge faults and restart the motor after any tripping. To allow the drive to be switched to a motor shaft that is still rotating, the "flying restart" function must be activated via P1200.

 WARNING
When the "automatic restart" function is active (P1210 > 1), a motor can restart automatically once the power has been restored. This is particularly critical if it is incorrectly assumed that the motors have been shut down after a long power failure. For this reason, death, serious injury, or considerable material damage can occur if personnel enters the working area of motors in this condition.

Commissioning the automatic restart

1. Parameterizing the automatic restart using P1210
2. Set the number of start attempts via P1211.
3. If, for an automatic restart, the inverter is to be connected to an already rotating motor, then the 'flying restart' function should also be activated using P1200.
4. Make sure that this functions properly.

Parameterizing the automatic restart

Table 6- 42 Parameterizing the automatic restart

Parameter	
P1210 =	<p>Automatic restart mode</p> <p>0: Automatic restart locked</p> <p>1: Fault acknowledgment after an ON command; P1211 locked (factory setting)</p> <p>2: Automatic restart after a power failure; P1211 locked</p> <p>3: Automatic restart after a line supply undervoltage or fault; P1211 enabled</p> <p>4: Automatic restart after a line supply undervoltage; P1211 enabled</p> <p>5: Automatic restart after a power failure and fault; P1211 locked</p> <p>6: Automatic restart after a line supply undervoltage / failure or fault; P1211 locked</p>
P1211 =	<p>Number of automatic restart attempts [minimum 0 ... maximum 10]</p> <p>3 (factory setting)</p>
P1200 =	<p>Starts inverter onto a spinning motor by rapidly changing the output frequency of the inverter until the actual motor speed has been found. Then, the motor runs up to setpoint using the normal ramp time.</p> <p>0: Flying start disabled</p> <p>1: Flying start always active, start --> setpoint</p> <p>2: Flying start active if power on, fault, OFF2, start --> setp.</p> <p>3: Flying start active if fault, OFF2, start --> setpoint</p> <p>4: Flying start always active, only --> setpoint</p> <p>5: Flying start active if power on, fault, OFF2, only --> setp.</p> <p>6: Flying start active if fault, OFF2, only --> setpoint</p> <p>Flying start must be used in cases where the motor may still be turning (e.g. after a short mains break) or can be driven by the load. Otherwise, overcurrent trips will occur.</p> <p>Useful for motors with high inertia loads. Settings 1 to 3 search in both directions. Settings 4 to 6 search only in direction of setpoint.</p>

Table 6- 43 Principle of operation of the automatic restart

<p>P1210 = 0: Automatic restart locked (this is a practical setting for a networked drive)</p> <p>After the line supply voltage returns, possible faults must be acknowledged. After this, the ON command must be switched-in again in order that the inverter starts.</p>
<p>P1210 = 1: Fault acknowledgment after ON command (P1211 locked)</p> <p>After a power failure, the inverter automatically acknowledges all faults (it resets them), as soon as the line supply voltage returns.</p> <ul style="list-style-type: none"> • Faults due to a line supply undervoltage are not automatically acknowledged. • The motor does not automatically start. • The motor only starts to rotate again if an ON command is issued again after the line supply voltage returns.

<p>P1210 = 2: Automatic restart after power failure - no additional start attempts (P1211 locked)</p> <p>After power failure, the inverter automatically acknowledges fault F0003 (resets it), as soon as the line supply voltage is available again; and automatically restarts.</p> <ul style="list-style-type: none"> • All other faults are not automatically acknowledged. • Faults due to a line supply undervoltage are not automatically acknowledged. • Switching the ON command in the de-energized state only results in an automatic start if the inverter was in the "ready" state when the power failed.
<p>P1210 = 3: Automatic restart after a line supply undervoltage or fault - with additional start attempts (P1211 enabled)</p> <p>After a line supply undervoltage, the inverter automatically acknowledges all faults (resets them), as soon as the line supply voltage is again available; and automatically restarts.</p> <ul style="list-style-type: none"> • This behavior is independent of the power failure or line supply undervoltage. • Switching the ON command in the de-energized state has no effect, if the inverter was "ready" before the power failure. • The number of start attempts can be set. (If the automatic restart is interrupted due to a new fault)
<p>P1210 = 4: Automatic restart after a line supply undervoltage (P1211 enabled)</p> <p>After power failure or a line supply undervoltage, the inverter automatically acknowledges fault F0003 (resets it), as soon as the line supply voltage is again available; and automatically starts.</p> <ul style="list-style-type: none"> • All other faults are not automatically acknowledged. • An ON command in the de-energized state has no effect. • The number of start attempts can be set. (If the automatic restart is interrupted due to a new fault)
<p>P1210 = 5: Automatic restart after power failure and fault (P1211 locked)</p> <p>After a power failure, the inverter automatically acknowledges all faults (resets them), as soon as the line supply voltage is again available; and automatically starts.</p> <ul style="list-style-type: none"> • Faults due to a line supply undervoltage are not automatically acknowledged. • Switching the ON command in the de-energized state always results in automatic restart. Possible faults are first automatically acknowledged.
<p>P1210 = 6: Automatic restart after line supply undervoltage / power failure or fault (P1211 locked)</p> <p>The inverter automatically acknowledges all faults (resets them), as soon as the line supply voltage is again available; and automatically starts.</p> <ul style="list-style-type: none"> • This behavior is independent of the power failure or line supply undervoltage. • If the ON command is switched-on during the power failure, then an automatic start is always formed. Possible faults are first automatically acknowledged.

Automatic restart characteristics

Table 6- 44 Overview of the automatic restart characteristics

P1210	ON command always active (continuously)				ON command in the de-energized state	
	Fault F0003 due to		All other faults		Inverter signals a fault Before power failure	Inverter ready Before power failure
	Power failure	Line supply undervoltage	Before power failure	in operation		
0	--*	--*	--*	--*	--*	--*
1	Fault acknowledgement	--*	Fault acknowledgement	--*	Fault acknowledgement	--*
2	Fault acknowledgement + restart	--*	--*	--*	--*	Restart
3	Fault acknowledgement + restart	Fault acknowledgement + restart	Fault acknowledgement + restart	Fault acknowledgement + restart	Fault acknowledgement + restart	--*
4	Fault acknowledgement + restart	Fault acknowledgement + restart	--*	--*	--*	--*
5	Fault acknowledgement + restart	--*	Fault acknowledgement + restart	--*	Fault acknowledgement + restart	Restart
6	Fault acknowledgement + restart	Fault acknowledgement + restart	Fault acknowledgement + restart	Fault acknowledgement + restart	Fault acknowledgement + restart	Restart

*) -- = no action

6.9.3.2 Flying restart

Description

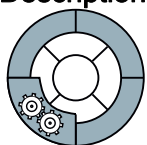

CAUTION
Parameter P1215
If the parameter P1215 is active, that is, P1215=1 then the flying restart function will not work. P1215 must be disabled (P1215=0) to ensure that the flying restart function operates correctly.

The "flying restart" function, which is activated by P1200, allows the inverter to be switched to a rotating motor. The function must be used whenever a motor may still be running. This could be:

- After a brief line interruption
- When an inverter is shut down but air currents cause a fan impeller to rotate (either CW or CCW)
- If the motor is driven by a load

This function is useful, therefore, with motors whose load exhibits a high moment of inertia since it can help prevent sudden loads in the mechanical components.

If this function is not used in such cases, this could cause the motor to shut down due to overcurrent (overcurrent fault F0001).

The "flying restart" function can be used to synchronize the inverter and motor frequency.

 WARNING
<p>Drive starts automatically</p> <p>When this function is enabled (P1200 > 0), all those working with the system must be informed of the following:</p> <ul style="list-style-type: none"> • The drive starts automatically. • Although the drive is at a standstill, it can be started by the search current.

Input values

Table 6- 45 Main function parameters

Parameter	Description
P1200 = ...	Flying restart 0: locked (factory setting), 1 - 6 Active

Table 6- 46 Overview: the "flying restart" function

P1200	Flying restart active	Search direction
0	Flying restart locked (factory setting)	-
1	Flying restart always active	Search performed in both directions, startup in direction of setpoint
2	Flying restart active after: <ul style="list-style-type: none"> • Power ON • Faults • OFF2 	Search performed in both directions, startup in direction of setpoint
3	Flying restart active after <ul style="list-style-type: none"> • Faults • OFF2 	Search performed in both directions, startup in direction of setpoint
4	Flying restart always active	Search performed in direction of setpoint only

P1200	Flying restart active	Search direction
5	Flying restart is active after <ul style="list-style-type: none"> • Power ON • Faults • OFF2 	Search performed in direction of setpoint only
6	Flying restart is active after <ul style="list-style-type: none"> • Faults • OFF2 	Search performed in direction of setpoint only

Table 6- 47 Additional commissioning parameters

Parameter	Description
P1202 = ...	Motor current: Flying restart (entered in %): 10 % ... 200 %, factory setting 100 % Defines the search current with respect to the rated motor current (P0305) that is present when the "flying restart" function is used.
P1203 = ...	Search rate/speed: Flying restart (entered in %): 10 % ... 200 %, factory setting 100 % Sets the factor by which the output frequency changes during the flying restart to synchronize itself with the running motor.

Note

The higher the search rate (P1203), the longer the search time. A lower search rate shortens the search time.

The "flying restart" function decelerates the motor slightly. The smaller the drive torque, the more the drive is decelerated.

The "flying restart" function should not be activated for motors in group drives due to the different coasting characteristics of the individual motors.

6.9.4 PID technology controller

Technology controller for processing higher-level control functions

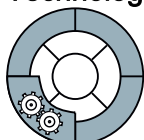

The technology controller supports all kinds of simple process control tasks. For example, it is used for controlling pressures, levels, or flow rates.

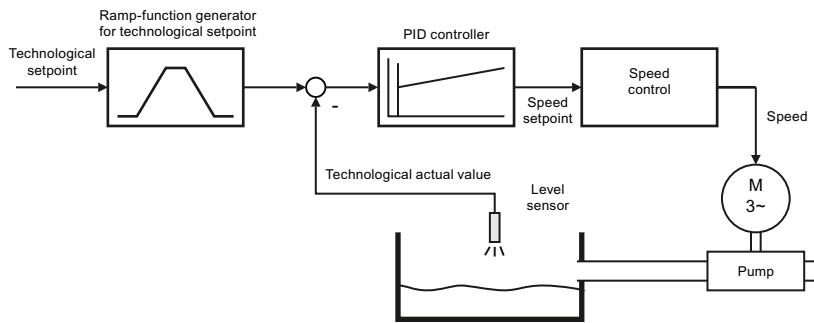

Figure 6-14 Example: technology controller as a level controller

The technology controller specifies the speed setpoint of the motor in such a way that the process variable to be controlled corresponds to its setpoint. The technology controller is designed as a PID controller, which makes it highly flexible.

The technology controller setpoint can be supplied via the same setpoint sources as those available for the speed setpoint. The technology controller is also equipped with its own motorized potentiometer and own fixed frequencies.

The setpoints, actual values, and control signals of the technology controller are defined by means of BICO technology.

Table 6- 48 Technology controller parameters

Parameter	Description
P2200 = ...	Enable technology controller
P2201 ... r2225	Fixed frequencies
P2231 ... P2248	Motorized potentiometer
P2251 ... r2294	Technology controller parameters

You will find more information about this function in the parameter list and in (function diagram 5100 of the List manual).

6.9.5 Logical functions using function blocks

Description

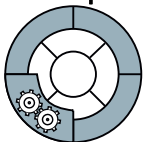

Additional signal interconnections in the inverter can be established by means of free function blocks. Every digital and analog signal available via BICO technology can be routed to the appropriate inputs of the free function blocks. The outputs of the free function blocks are also interconnected to other functions using BICO technology. Among others, the following unassigned function blocks are available:

- AND blocks, OR blocks, XOR blocks, NOT blocks
- Memory elements

Example: OR logic operation

You want to switch-on the motor via digital input 0 and also via digital input 1:

1. To do so, interconnect the status signals of digital inputs r722.0 and r722.1 with the inputs of a free OR block via BICO.
2. Now activate the OR block.
3. Finally, interconnect the OR block output with the internal ON command (P0840).

Table 6- 49 Parameters for using the free function blocks

Parameters	Description
P2800 = ...	Enable FFBs (General enable for all function blocks) 0: locked 1: enabled
P2801 = ...	Activate FFBs (activation of the individual function blocks)
P2802 = ...	
P2803 = ...	Activate fast FFBs (enable an 8ms time slice to calculate the activated, fast function blocks) 0: All function blocks are calculated with a 128 ms time grid 1: Some of the function blocks can be calculated with an 8 ms time grid.

Example: AND logic operation

An example of an AND logic operation, explained in detail, is provided in the Section "BICO technology".

For more information about this function, see function diagrams 4800, 4810, 4820, and 4830 in the List Manual.

6.9.6 Changing over drive data sets

Switching motor control

In certain applications, the inverter parameters need to be switched.

Example: Operating different motors on one inverter

One inverter should operate one of two different motors. Depending on which motor is to run at any given time, the motor data and the ramp-function generator times for the different motors must be adjusted accordingly in the inverter.

Drive data sets (DDS)

The inverter provides the possibility of parameterizing the following functions in up to three different ways:

- Setpoint sources
(exceptions: Analog inputs and fieldbus)
- Setpoint calculation
- Motor control

6.9 Technological functions

- Motor and inverter protection
- Technological functions
(Exception: Technology controller, brake control, automatic restart and unassigned function blocks)

The associated parameters are indexed (index 0, 1 or 2). Control commands select one of the three indices and therefore one of the three saved settings.

This means, that as described in the example above, you can switch over all of the settings of the inverter matching the particular motor.

All of the switchable parameters of the five functions mentioned above with the same index is known as a "command data set".

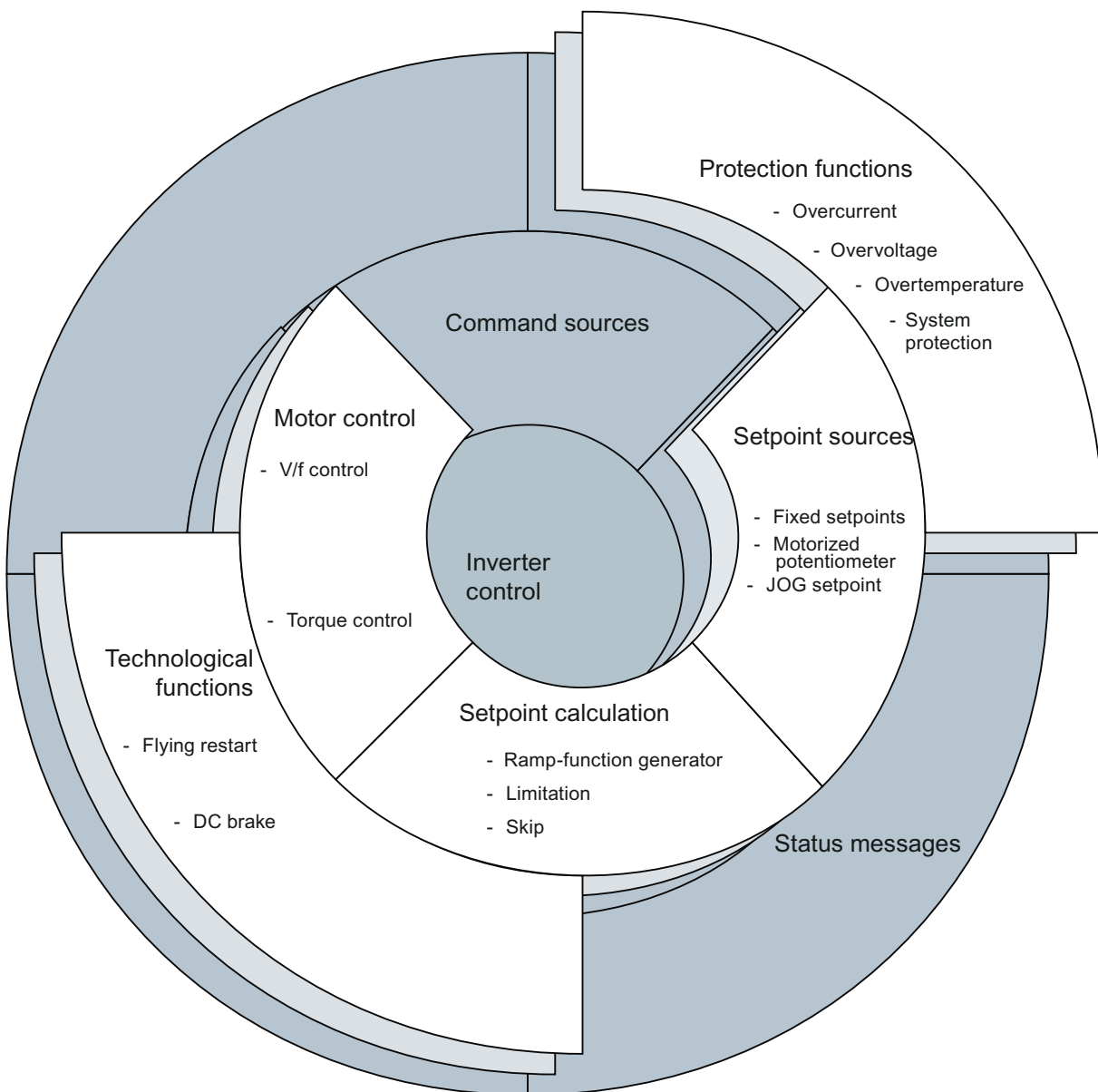

Figure 6-15 Drive Data Sets switchover in Inverter

The drive data sets are switched over using parameters P0820 and P0821. Parameters P0820 and P0821 are interlinked to control commands, e.g. the digital inputs of the inverter, using BICO technology.

Note

Drive data sets can only be changed over in the "ready for operation" state. The switchover time is approx. 50 ms.

Exceptions: The ramp-function generator parameters, the ramp-down time for OFF3, and the speed controller gain can be switched during operation.

Table 6- 50 Parameters for switching the drive data sets:

Parameter	Description
P0820 = ...	1st control command for switching the drive data sets Example: When P0820 = 722.0, the system switches from drive data set 0 to drive data set 1 via digital input 0
P0821 = ...	2nd control command for switching the drive data sets
r0051	Displaying the number of the DDS that is currently active
A copy function is available making it easier to commission more than one drive data set:	
P0819.0 = ...	Number of the drive data set to be copied (source)
P0819.1 = ...	Number of the drive data to which the data is to be copied (target)
P0819.2 = 1	Start copying

For an overview of all the parameters that belong to the drive data sets and can be switched, see the List Manual.

6.10 Quick Stop function

Overview

The Quick Stop function enables a load on a conveyor system to be detected and if Quick Stop is enabled, stop the load on the conveyor section.

The load on the conveyor section moves towards a dedicated sensor, as shown in the figure below.

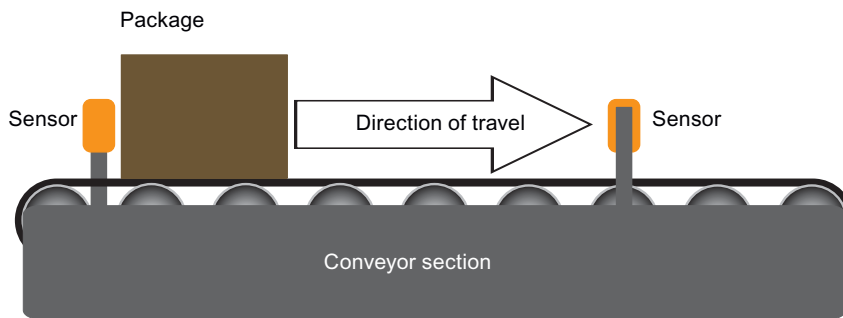

Figure 6-16 Conveyor example 1

The front edge of the load is detected by the sensor, which initiates the Quick Stop function.

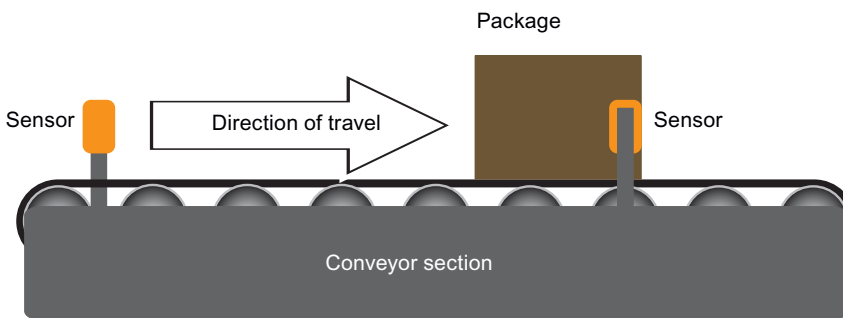

Figure 6-17 Conveyor example 2

The load is then slowed down and stopped.

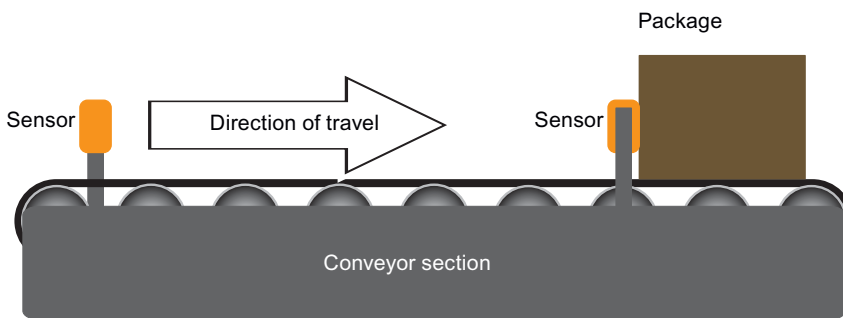

Figure 6-18 Conveyor example 3

There are two sensors on the conveyor section, so that the Quick Stop function can stop the conveyor section in either direction when a load is detected.

How does it work?

The Quick Stop function is configured using BICO parameters and they are explained in the table below.

Table 6- 51 Quick Stop parameters

Parameter	Description	Remarks
P0881	Quick Stop function Input 1 is ON	Allows Quick Stop source 1 command to be selected using BICO. The signal is expected to be active low (default setting P0886 = 2).
P0882	Quick Stop function Input 2 is ON	Allows Quick Stop source 2 command to be selected using BICO. The signal is expected to be active low (default setting (P0886 = 2).
P0883	Quick Stop override	Allows Quick Stop override command source to be selected using BICO. The signal is expected to be active high.
r0885	Quick Stop status	Bit field describing status of quick stop Bit /description 1 0 00: Quick Stop is active Yes No 01: Quick Stop selected Yes No 02: Override selected Yes No 03: Keypad control active Yes No 04: Quick Stop Enabled Yes No
P0886	Quick Stop input type	Control Word for selecting the Quick Stop input type. 0: Quick Stop not selected 1: Quick Stop input active high 2: Quick Stop input active low 3: Quick Stop input positive edge triggered 4: Quick Stop input negative edge triggered

When the Quick Stop function is activated, an OFF1 command is initiated. The motor will be slowed and brought to a standstill using the ramp-down times set in parameter P1121. The default setting for P1121 is 10 seconds and this value may need adjusted to ensure that the load on the conveyor section is brought to a halt at the correct position on the conveyor section

Setting the ramp-down time too short can cause the Inverter to trip with either an overcurrent or overvoltage fault.

The controlling system, for example, the AS-i controller detects that the Quick Stop function has been activated and can, by use of the appropriate ON command or the 'Quick Stop override' signal restart the motor as required.

Using parameter P0886, it is possible to set the type of reaction required to stop the conveyor section. There are basically two trigger methods, edge triggered signals or level triggered signals. Each type of triggering method produces a different reaction to the OFF1 command and the restarting of the motor. These reactions are shown in the figures below:

6.10 Quick Stop function

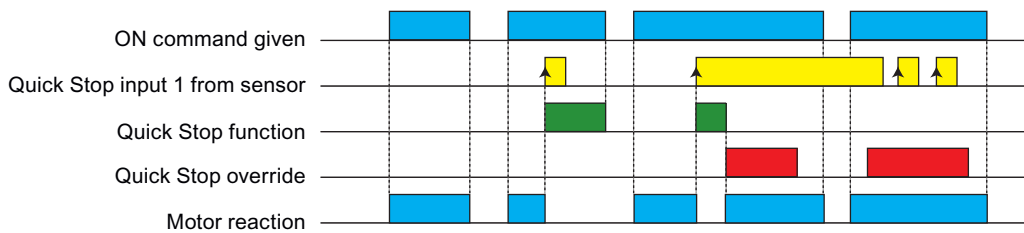

Figure 6-19 Positive edge triggered signals reactions

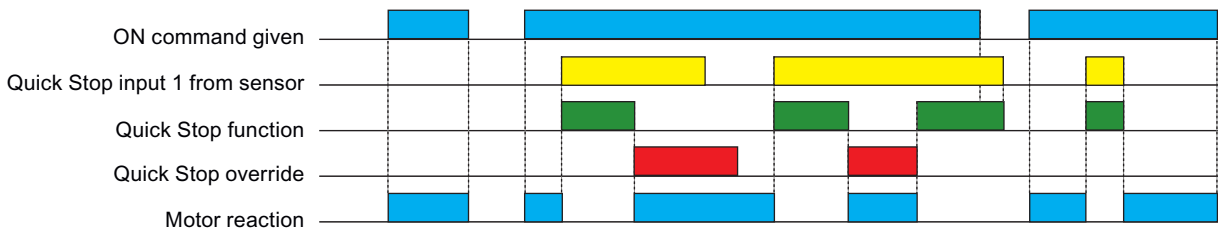

Figure 6-20 High level triggered signals reactions

The 'Quick Stop override' command is normally sent by the controlling system, but the local keypad can also be used to initiate the 'Quick Stop override'. The keypad is switched into local mode and by pressing the 'Quick Stop override' button, the motor will be started by the Inverter. See figure below.

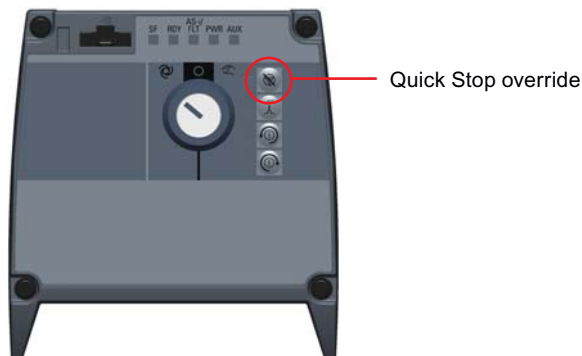

Figure 6-21 Keypad Quick Stop override

6.11 Operation in fieldbus systems

6.11.1 Communication via AS-i Network

6.11.1.1 Overview

Overview

The Actuator/Sensor Interface or AS-Interface, normally abbreviated to AS-i, is a connection system for the lowest process level in an automation system. The system is controlled and monitored by an AS-i Master. This single master controls and monitors the AS-i network by means of cyclic polling technique. This means that the master polls all the data passed from all the slave nodes at a predefined interval.

A typical AS-i network structure is shown in the figure below.

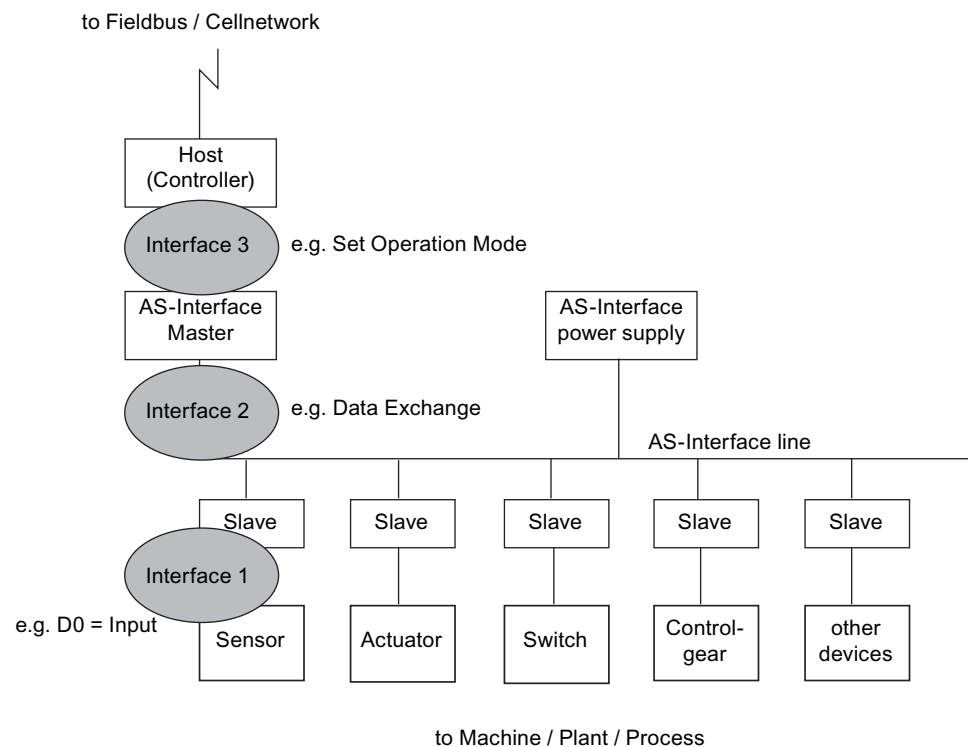

Figure 6-22 AS-i network structure

AS-i is a low speed (166 kbps) two-wire bus and the physical signalling method is Manchester coded current pulses superimposed on the 28 V power supply. Since the power supply is used for communications, it must be decoupled with inductors in order for the receiver to be able to decode the transmitted messages. The basic data exchanged is four bits in each direction each time a slave is polled. A second cable is used for an auxiliary 24 V supply which provides power for the electronics inside the Inverter. No communications takes place of this second cable.

In the diagram below an example is given of how the Manchester coded current pulses are used for communicating data.

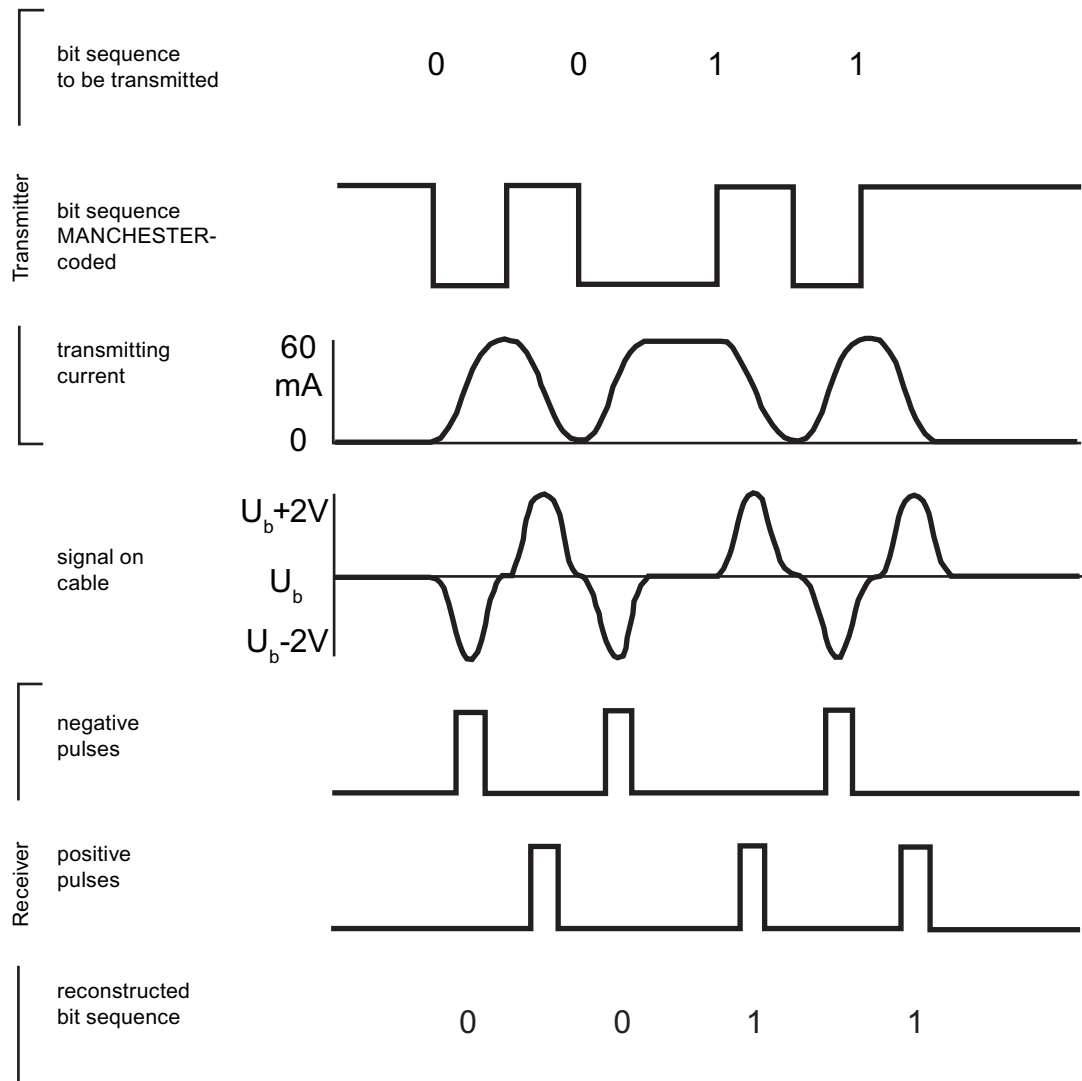

Figure 6-23 AS-i communications using Manchester coding

Up to 31 standard slaves can be connected to the bus. This figure is doubled to 62 extended A/B slaves where one of the communication bits from the master is used to allow two slaves to share an address. When this is done the two slaves are referred to as A and B, and the master communicates with each on alternate cycles.

The basic communication system of AS-i allows only 4 bits of digital data to be transferred between master and slave. While this is sufficient for simple applications for which AS-i was originally intended, more complex applications require more data such as analogue values or serial transfers. To address this requirement version 3.0 of the AS-i standard introduced 'combined transactions' in which some of the data bits from the basic communications are used to implement a serial interface capable of transferring both cyclic and acyclic data.

6.11.1.2 Connecting the Inverter to AS-i network

Connecting the Inverter to the AS-i network

Assignment of the M12 connector to connect to the AS-i network

The SINAMICS G110D Inverter has one M12 AS-i connection to allow connection the the AS-i network. The pin assignment of the M12 connector is shown in the table below.

Table 6- 52 ASI connector specifications

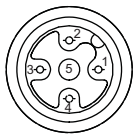
ASI connections				
	Pin	Function	Description	Cable colour
	1	ASi+	AS-i positive	Yellow
	2	0V	Auxiliary 0 V	Black
	3	ASi-	AS-i negative	Yellow
	4	24V	Auxiliary 24 V	Black
	5	Function earth	Earth connection	-

Recommended AS-i connector

We recommend the following AS-i M12 branch connector for connection to the AS-i network.

- AS-i M12 connection kit (3RK1901-1NR21)

Permissible cables and cable lengths

AS-i yellow data cable - 3RX9013-0AA00

AS-i black power cable - 3RX9023-0AA00

The maximum length of any one segment on the AS-i network is normally 100 m (328 ft). However there are a number of devices that allow the length of network segments to be extended.

Repeater

A repeater allows the maximum cable length to be extended to 300 m (984 ft) using the maximum of two repeaters. Slave nodes can be used on both sides of a repeater.

Extender

The extender allows the distance between the AS-i master and an AS-i segment of the network to be extended to a maximum of 100 m (328 ft). With repeaters connected in parallel, a cable length significantly longer than 300 m (984 ft) can be achieved. The maximum span is 500 m (1640 ft). The only limitation of the extender is that slaves can only be used downstream from the extender.

Extension plug

Using the extension plug, the maximum possible cable length in an AS-i segment can be doubled from 100 m (328 ft) to 200 m (656 ft). The extension plug is a passive device and is connected to the part of the AS-i network furthest from the power unit. Only one power unit is required to power the slaves on the segment up to 200 m (656 ft).

6.11.1.3 Example: configuring the Inverter on the AS-i network

Example: configuring the Inverter on an AS-i network

Task

To integrate the Inverter on an existing AS-i network under the control of an AS-i master. The control signals and speed setpoints will be transferred through the AS-i master to the Inverter. In the other direction, the Inverter is to transfer its status messages and actual speed value to the higher-level controller through the AS-i master.

What prior knowledge is required?

This section does not explain how to use the higher-level controller or the various software engineering tools.

Hardware components (example)

Component	Type	Order no.	Qty
AS-i devices and cables			
AS-i Master	CP343-2	6GK7343-2AH01-0XA0	1
AS-i Power supply unit	-	3RX9-501-0BA00	1
AS-i Cable Trapezoidal	Yellow	3RX9013-0AA00	See note 1
AS-i Cable Trapezoidal	Black	3RX9023-0AA00	See note 1
AS-i M12 connection kit	-	3RK1901-1NR21	1
Inverter			
SINAMICS G110D	Frame size A - 0.75 kW	6SL3511-0PE17-5AM0	See note 2
IOP	Intelligent Operator Panel	6SL3255-0AA00-4AA0	1
Motor			
Standard motor	Three-phase induction motor	1LA7060-4AB10	1

Notes:

1. Cable length depends on the user requirements and cannot be specified.
2. Although the SINAMICS G110D FSA Inverter is specified, all the SINAMICS G110D Inverters are configured in the same manner

Software components

Component	Type	Order no.	Qty
SINAMICS STEP 7	V5.3 + SP3 or higher	6ES7810-4CC07-0YA5	1
Drive ES Basic	V5.4 or higher	6SW1700-5JA00-4AA0	1

Drive ES Basic is the basic software of the engineering system, which combines the drive technology and Siemens controllers. The STEP 7 Manager user interface acts as a basis with which Drive ES Basic is used to integrate drives in the automation environment with respect to communication, configuration and data storage.

Integrating the Inverter in a AS-i master

The CP343-2 module can be operated in the automation systems (AS or PLC) of the S7-300 series and in the ET200M system. It allows the connection of an AS-i chain to the programmable controllers.

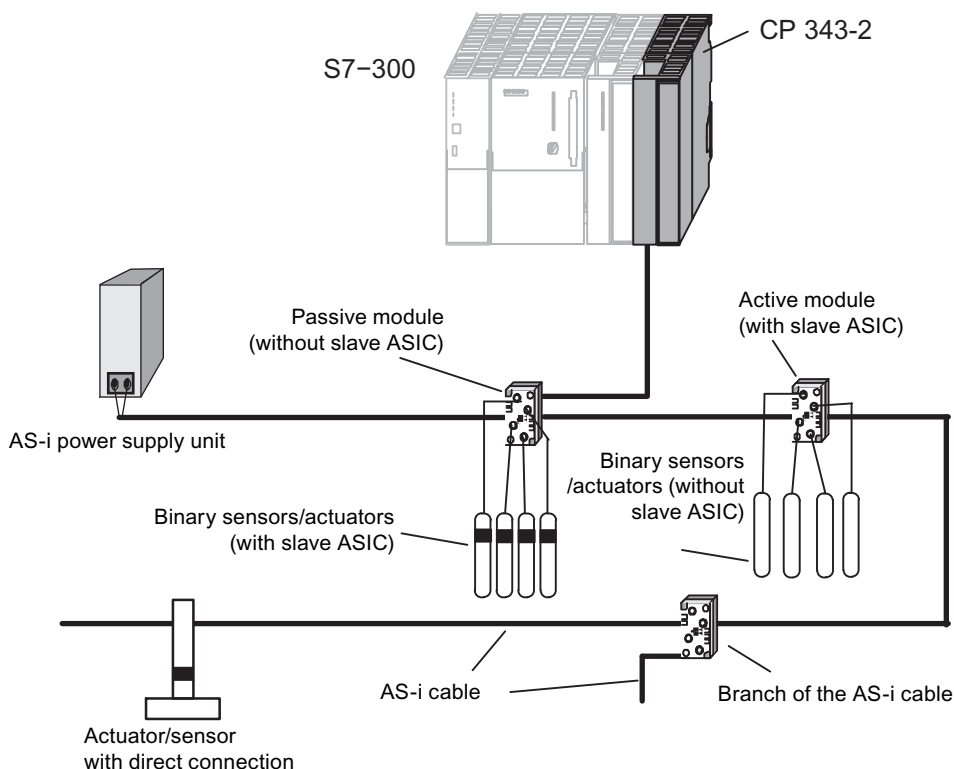



Figure 6-24 Using the CP343-2 Master with the S7-300

Installing and commissioning the CP343-2

To install a SIMATIC S7-300 the procedure is outline below. This procedure is given as an overview and the Operating Instructions and Installation guidelines for the S7-300 must be consulted for detailed information.

 CAUTION
<p>Load capacity</p> <p>The load capacity of the AS-i contacts is a maximum of 4A. If this value is exceeded on the AS-i cable, the CP343-2 must not be "looped into" the AS-i cable but must be connected by a separate cable (only one pair of CP343-2 terminals used).</p>

Step	Explanation/meaning
Note: Only wire-up the S7-300 with the power switched off! Follow the steps as described in the S7-300 Operating Instructions when wiring between the power supply and the CPU.	
Install the CP343-2 on the S7 standard rail.	Slots 4 to 11 are permitted for the CP343-2 in racks 0 to 3.
Establish the connection through the enclosed bus connector to the backplane bus.	
Secure the CP343-2 by the screws in its casing.	
Connect the AS-i cable to the terminals on the front connector of the CP343-2	Contact is made at terminal pairs 17 and 19 or 18 and 20 of the front connector. Terminals 17 and 19 and terminals 18 and 20 are electrically connected within the CP343-2. The assignment of the terminal pair and the polarity are indicated on the front panel of the CP343-2. The second terminal pair (18/20) is intended for connecting the AS-i power supply unit or a branch of the AS-i cable. This allows the CP343-2 to be "looped" into the AS-i cable. The AS-i power supply unit can, however, be connected to any point on the AS-i cable.
Turn on the power supply for the SIMATIC station and the AS-i system.	

Setting the slave address of the Inverter

This step assumes that the Inverter has been installed and commissioned as previously described in this manual.

The SINAMICS G110D Inverter has the equivalent of two slave nodes to be identified to the AS-i network.

The simplest way to set the slave addresses is to allow the AS-i master to poll the network, once the Inverter has been installed correctly, and it will automatically assign an address to any slave devices with an address of '0'. '0' is the default slave address assigned to both slave nodes of the Inverter. One slave node is hidden from the network, when the first slave node is assigned a node address, the second node becomes visible to the network and the AS-i master will then assign the relevant node address to the second node. The polling is initiated by pressing the "Set button" on the AS-i master.

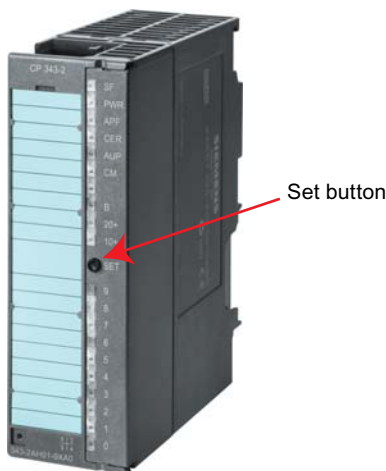

Figure 6-25 AS-i master - set button

The second method is to use the AS-i programming unit to manually set the address of both the Inverter slave nodes.

Connect the AS-i programming unit to the Inverter (as shown below). The AS-i address connection is underneath the Control Module cover.

Once the AS-i programming unit is connected, turn the main dial to "ADDR", the screen will then display an AS-i slave address of '1'. Using the 'up' and 'down' cursor keys, navigate to the required address. Press the return button (on the far right) to confirm and enter the address into the slaves memory. Repeat this process for the second slave address required by the Inverter.

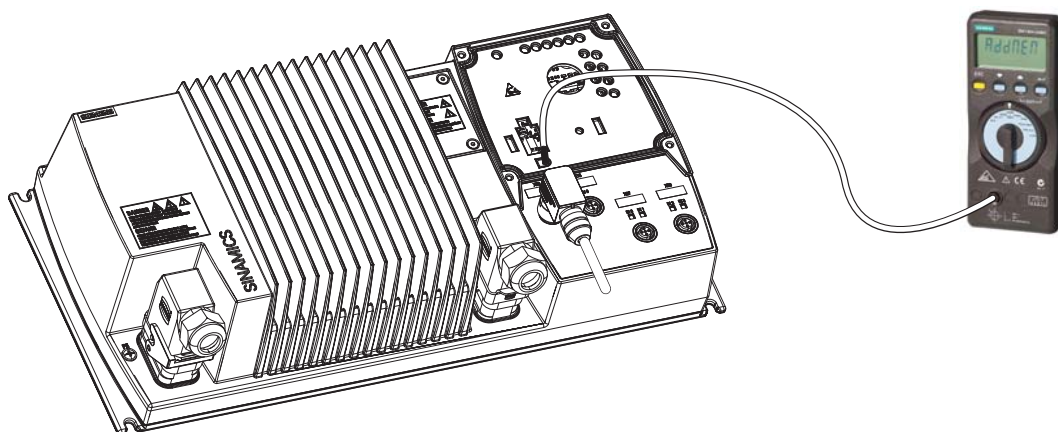

Figure 6-26 Setting the address on the Inverter

Configuring the AS-i master

The CP343-2 is taken from the hardware catalog in STEP 7 HW Config just like any other module and placed in the required slot in the rack of the S7-300 station.

After you have inserted the CP343-2, there are still no AS-i slaves configured. In this default setting the rules of "button configuration" apply initially.

To view general information, addresses and operating parameters and to configure or modify them, change to the properties dialog of the CP343-2 in STEP 7.

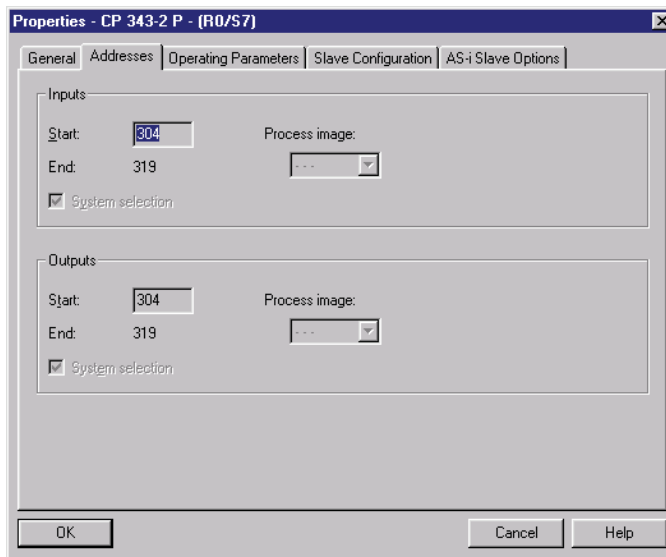

Figure 6-27 Properties dialog CP343-2 - addresses

The start addresses for both the inputs and outputs must be identical. The default setting for the reserved data length is 16 bytes.

Operating parameters

Automatic address programming is set by default, i.e. if a slave is replaced due to a fault, the slave that replaces it will be automatically assigned the previous slaves address. If this action is not required it can be deselected.

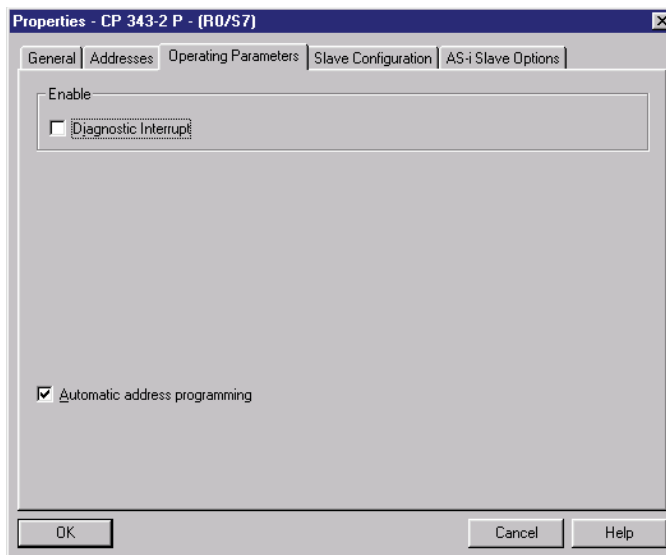

Figure 6-28 Properties dialog CP343-2 - operating parameters

Configuring AS-i slaves

Note

Configuration overwritten

A configuration of the AS-i slaves set by STEP 7 and downloaded to the S7 station is transferred from the CPU to the CP343-2 when the S7 station starts up. Any configuration set with the buttons is then overwritten.

To configure a specific slave configuration, select the "Slave Configuration" tab.

Double-click on the row in the displayed table in which you want to enter an AS-i slave with the corresponding address; this opens the properties dialog for AS-i slaves.

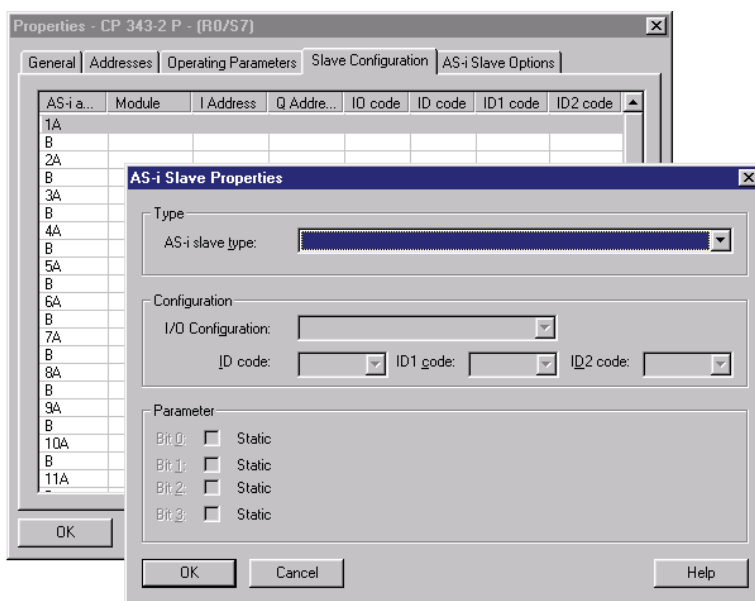

Figure 6-29 Properties dialog CP343-2 - slave configuration

Select the AS-i slave from the drop-down list. Three basic types of AS-i slave are available:

- AS-i slave universal - AS-i slave with extended addressing mode
- AS-i standard slave universal or AS-i analog slave - AS-i slave for the standard address area; if you use this slave type, you cannot place an AS-i A/B slave at the same address in the B address area.
- Siemens slaves - with this option you can configure the AS-i slave by simply selecting the relevant order number from the drop-down list.

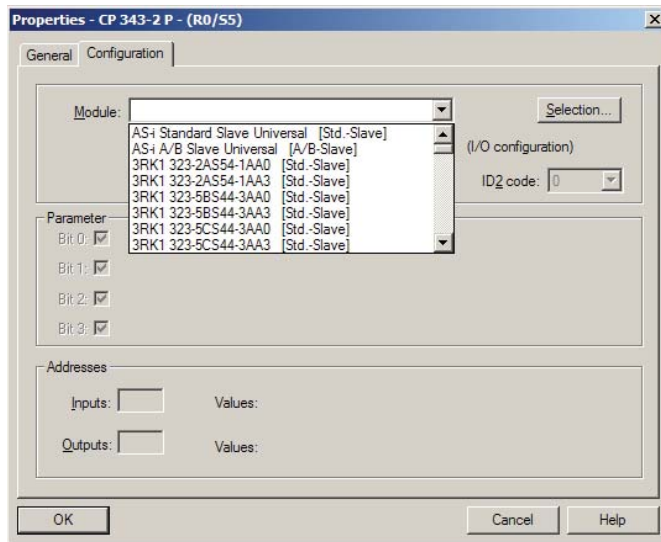

Figure 6-30 Configuring an individual slave

Configuring the properties of an AS-i slave

Using the individual property dialogs an slave can be configured with the following properties:

- Enter configuration data of the specific AS-i slave.
- Specify the I/O configuration.
- Set the AS-i parameters.

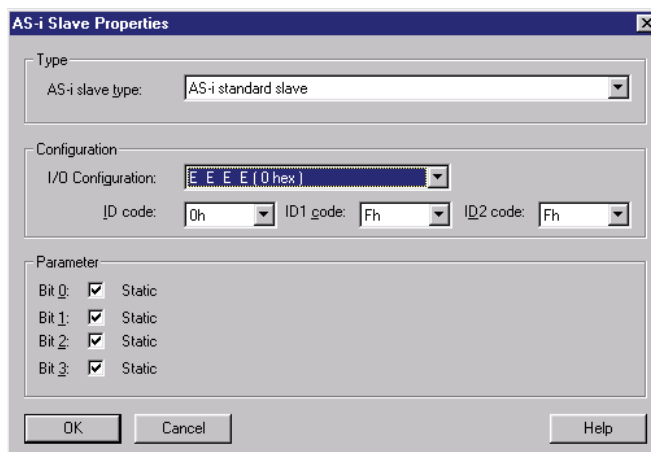

Figure 6-31 Configuring standard AS-i slave

The AS-i standard slave can only be placed at an AS-i address in the A area. This address is then no longer available in the B area.

As an option, at start-up parameters can be permitted - whether this parameter can be used depends on the slave type.

If the AS-i slave does not support the ID1/ID2 codes, the values F (hex) must be entered.

6.11.1.4 AS-i Profile

AS-i slave configurations

The Inverter uses the extended AS-i specification V3.0, specifically to allow serial communications over the AS-i bus. The specific profile used by the Inverter is S-7.A.5 which allows 50 bps bi-directional communications for 2 digital inputs and 2 digital outputs.

The Inverter contains two logical AS-i slaves, which can be used in either the single slave mode or the dual slave mode. Each of these modes are individually described below.

Single slave mode

In simple applications, and to allow the Inverter to be used with an AS-i master that does not support extended addressing the single slave mode can be selected.

When the Inverter is configured as a single slave, only process image data can be transferred over the AS-i bus. The single slave mode does not support extended addressing so the number of nodes available on the AS-i bus is limited to a maximum of 32 slaves.

The structure and flow of data is given in the diagram below.

Table 6- 53 AS-i single slave identities

Slave	IO code	ID code	ID2 code	Description
Single	7	F	E	Free profile slave with standard addressing.

Single or dual slave mode is selected using parameter P2022. The default mode for this parameter is dual slave mode. The settings for this parameter are given in the table below.

Table 6- 54 Selection of slave mode (P2022)

P2022 value	Description
0	Single slave mode without extended addressing.
2	Dual slave mode with extended addressing.

Note: After this parameter is changed, the Inverter will perform an AS-i reset in order to load the new profile information. The slave address will be reset to 0.

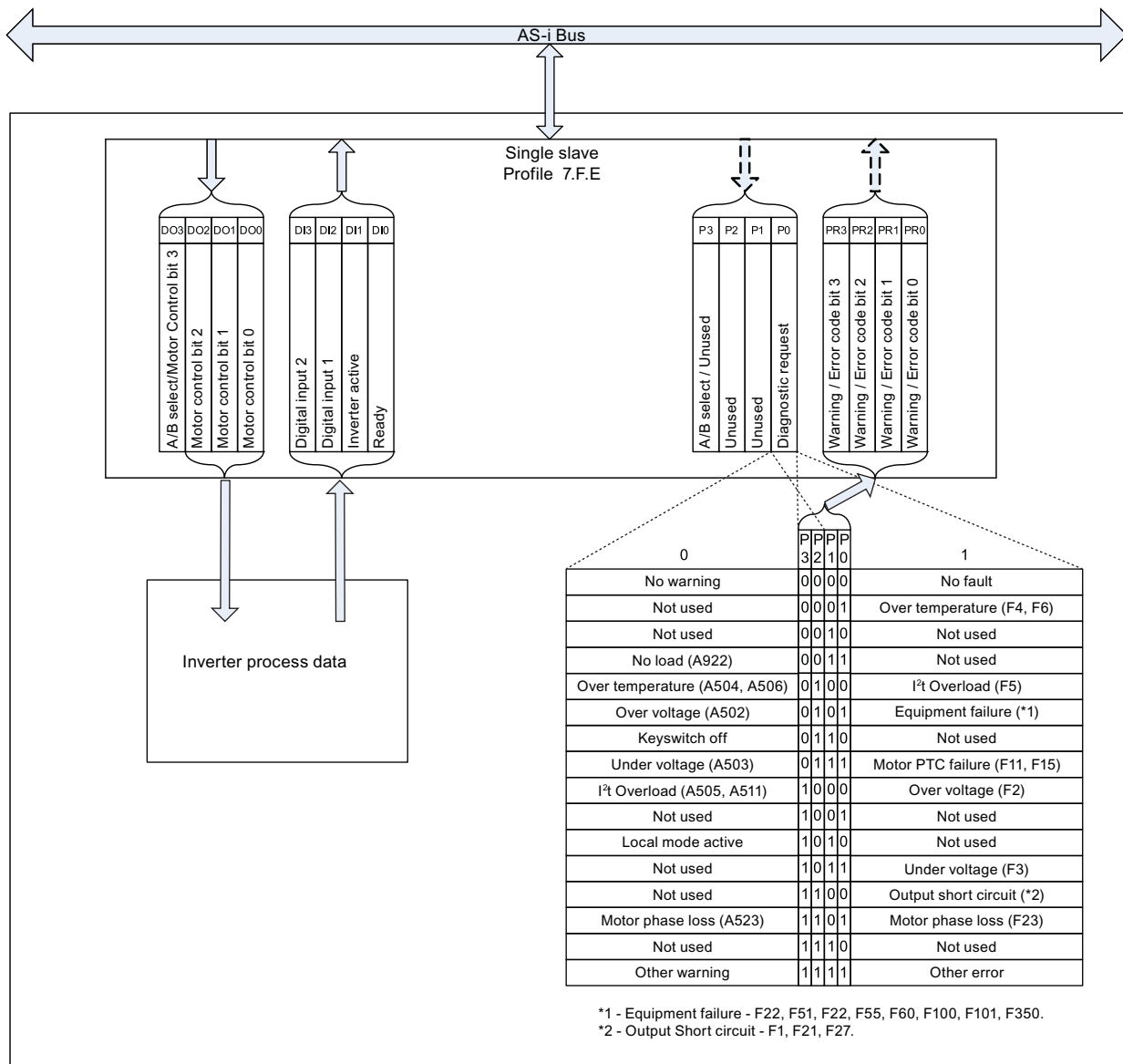

Figure 6-32 Single Slave Internal data flow

Dual slave mode

In the dual slave mode the Inverter appears as two logical slaves on the AS-i bus, although the slaves are actually contained within the same unit.

The first slave (Slave 1), utilizes the combined transaction type 2 (CTT2) protocol to allow both cyclic and acyclic transfer of parameter data to and from the master as well as digital process data.

The second slave (Slave 2) transfers further process data and allows access to basic diagnostic information through the reply to a parameter request.

The details of the individual slave identities are given in the table below:

Table 6-55 AS-i dual slave identities

Slave	IO code	ID code	ID2 code	Description
1	7	A	5	Combi field device
2	7	A	E	Free profile A/B slave

The structure and flow of data is given in the diagram below.

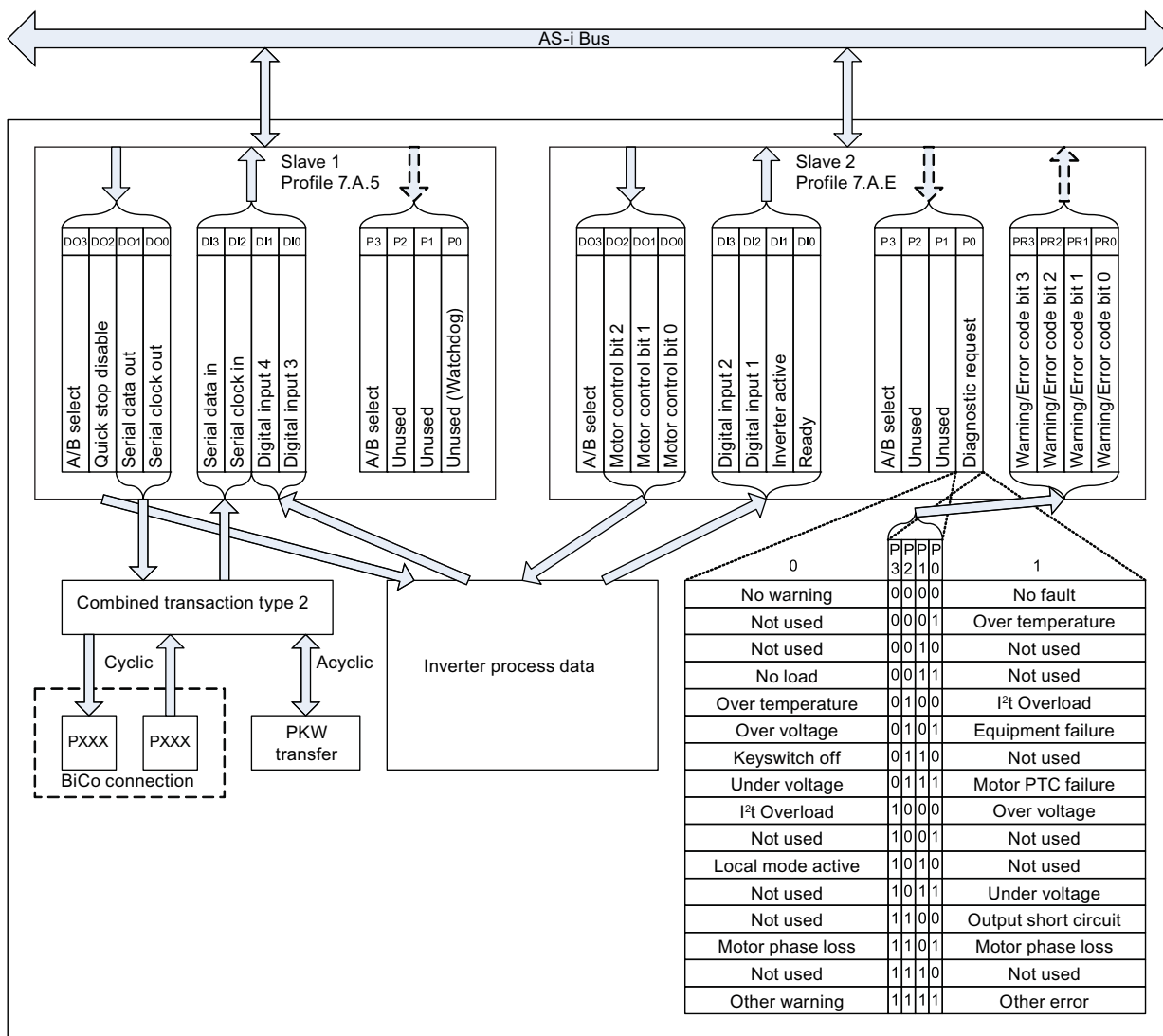

Figure 6-33 Dual slave internal data flow

Addressing

The Inverter use a standard M12 connector for connection to the AS-i bus. Since the connection between the inverter and bus is a spur, the Inverter can be disconnected from the bus, the addresses reassigned, and the inverter reconnected without interrupting communications elsewhere on the bus.

Auto addressing

Both slaves within the Inverter have the normal AS-i default address of '0'. When connected to the AS-i bus slave 1 will be visible to the AS-i master. This allows the master to find the Slave 1 and assign it an appropriate AS-i node ID on the connection AS-i network. When Slave 1 has been assigned an address, Slave 2 becomes visible to the AS-i network and can then be automatically assigned a node ID by the AS-i master.

Auto addressing (during commissioning)

During commissioning (If auto-addressing is used) all slaves receive an address from the AS-i master one after another.

If the AS-i master detects a slave with address 0, it automatically assigns an address to that device and integrates the device into the AS-i network.

The automatic address assignment and integration only works as long as one slave with address 0 is present on the AS-I master at a time. The inverter has 2 slave addresses, however the slave 1 will be hidden until the slave 2 has been assigned.

If there are more slaves with address 0, the automatic addressing is deactivated by the AS-i master and integration into the AS-i network is not possible. This is standard behaviour within AS-I networks.

Auto programming (during exchange of defective units)

If a inverter fails and is removed from the AS-i network, the AS-i master will detect that two addresses are missing from the bus.

In case of two unassigned AS-i addresses the AS-i master cannot guarantee the re-addressing of the slaves as per the original configuration of that AS-i network by auto-programming.

The automatic addressing is deactivated by the AS-i master and integration into the AS-i network is not possible. This is standard behaviour within AS-I networks.

In such a case, the addresses have to be set manually (using STARTER, IOP, an AS-i programming device, or manually using the AS-i master).

Setting the slave addresses to 0

If the addresses are set to 0 on the Inverter it is necessary to power-cycle of the AS-i bus (or by physically disconnecting and reconnecting the slave).

Addressing by parameter

The AS-i address of the two slaves in the Inverter are held in parameter P2021 using an index. Index 0 (P2021[0]) holds the address of Slave 1 and Index 1 (P2021[1]) holds the address of Slave 2. Parameter P2021 can take any value in the ranges 0 ... 31 for A slaves and 33 ... 63 for the B slaves.

When deciding addresses for the slaves the following points should be taken in account:

- Except for the special case of address '0', the two slaves must be assigned different addresses.
- If either slave is set to address '0' then both slaves will be set to address '0' and Slave 2 will become hidden from the AS-i network.

A summary of parameter P2021 values and conditions are given in the table below.

Table 6- 56 Summary of parameter P2021 settings

Parameter	Description
Dual slave mode	
P2021[0]	Address for slave 1, profile 7.A.5. Addresses available: 0...31 for A address, 33...63 for B addresses.
P2021[1]	Address for slave 2, profile 7.A.E. Addresses available: 0...31 for A address, 33...63 for B addresses.
Single slave mode	
P2021[1]	Address for slave 2, profile 7.F.E. Addresses available: 0...31 A address
Note: after this parameter is changed, the Inverter will perform an AS-i reset in order to load the new addresses.	

ID1 Code

The ID1 code according to the AS-i profile has no specific meaning and therefore can be modified by the user. Its purpose in the context of the Inverter, is to allow a unique number to be assigned to individual slave nodes on the AS-i bus. This function is useful, for example, when the AS-i master displays fault conditions for a specific slave node, its unique ID1 code can be used to physically identify the slave.

In single slave mode, there is one unique ID1 code for the Inverter; in dual slave mode, two unique numbers can be assigned to each logical slave node in the Inverter.

The ID1 code can be modified using parameter P2023. The settings and ranges of values for P2023 are given in the table below.

Table 6- 57 ID1 Code modification (P2023)

Slave mode	Parameter.index	Default value	Permissible range
Single slave without extended addressing	P2023.1	15	0...15
Dual slave 1 with extended addressing	P2023.0	7	0...7
Dual slave 2 with extended addressing	P2023.1	7	0...7

Programmable process images

It is possible, using BICO, to change the functionality of both input and output process images, with the exception of the CTT2 serial channel present in Slave 1. This serial channel is required to be present in order that Slave 1 appears correctly on the AS-i network. The default settings for both single slave and dual slave modes are given in the tables below.

Table 6- 58 Default input process image (slave to master) - Dual slave mode

Bit	Usage	Description
Slave 2		
DI0	Ready	0: Inverter is not responsive to AS-i master 1: Inverter is ready to respond to commands from the AS-i master
DI1	Motor active	0: Inverter motor outputs are high impedance 1: Inverter motor outputs are active
DI2	Digital input 1	0: Input 1 is inactive 1: Input 1 is active
DI3	Digital input 2	0: Input 2 is inactive 1: Input 2 is active
Slave 1		
DI0	Digital input 3	0: Input 3 is inactive 1: Input 3 is active
DI1	Digital input 4	0: Input 4 is inactive 1: Input 4 is active
DI2	Serial clock in	Clock signal for CTT2 data transfer to AS-i master
DI3	Serial data in	Data signal for CTT2 data transfer to AS-i master

Table 6- 59 Default output process image (master to slave) - Dual slave mode

Bit	Usage	Description
Slave 2		
DO0	Motor control bit 0	DO2 DO1 DO0
DO1	Motor control bit 1	0 0 0 OFF1
DO2	Motor control bit 2	0 0 1 Fixed frequency 1 (default 50 Hz)
		0 1 0 Fixed frequency 2 (default -50 Hz)
		0 1 1 Fixed frequency 3 (default 10 Hz)
		1 0 0 Fixed frequency 4 (default 15 Hz)
		1 0 1 Fixed frequency 5 (default 20 Hz)
		1 1 0 Fixed frequency 6 (default 25 Hz)
		1 1 1 With active trip: Fault ACK (1) With no Trip: OFF2 (2)
DO3	A / B select	0: 'A' slave active 1: 'B' slave active
Slave 1		
DO0	Serial clock out	Clock signal for CTT2 data transfer from AS-i master
DO1	Serial data out	Data signal for CTT2 data transfer from AS-i master
DO2	Quickstop override	0: Quick stop active 1: Quick stop override: allow Inverter to ignore quick stop
DO3	A / B select	0: 'A' slave active 1: 'B' slave active
<p>(1) The AS-i specification mandates the simultaneous use of 'Motor Left' and 'Motor Right' as fault acknowledge, particularly if there is no spare input available for this function.</p> <p>(2) If no fault is active then simultaneous operation of 'Motor Left' and 'Motor Right' constitutes a process image error. In this state both the inverter motor outputs and the motor holding brake outputs are inactive, causing the motor to coast to a halt and engaging the motor holding brake in exactly the same way as an OFF2 command. This state is maintained until both 'Motor Left' and 'Motor Right' are deactivated at the same time.</p>		

Table 6- 60 Default input process image (slave to master) - Single slave mode

Bit	Usage	Description
DI0	Ready	0: Inverter is not responsive to AS-i master 1: Inverter is ready to respond to commands from the AS-i master
DI1	Motor active	0: Inverter motor outputs are high impedance 1: Inverter motor outputs are active
DI2	Digital input 1	0: Input 1 is inactive 1: Input 1 is active
DI3	Digital input 2	0: Input 2 is inactive 1: Input 2 is active

Table 6- 61 Default output process image (master to slave) - Single slave mode

Bit	Usage	Description
DO0	Motor control bit 0	DO3 DO2 DO1 DO0
DO1	Motor control bit 1	0 0 0 0 OFF1
DO2	Motor control bit 2	0 0 0 1 Fixed frequency 1 (default 50 Hz)
DO3	Motor control bit 3	0 0 1 0 Fixed frequency 2 (default -50 Hz)
		0 0 1 1 Fixed frequency 3 (default 10 Hz)
		0 1 0 0 Fixed frequency 4 (default 15 Hz)
		0 1 0 1 Fixed frequency 5 (default 20 Hz)
		0 1 1 0 Fixed frequency 6 (default 25 Hz)
		0 1 1 1 Fixed frequency 7 (default 30 Hz)
		1 0 0 0 Fixed frequency 8 (default 35 Hz)
		1 0 0 1 Fixed frequency 9 (default 40 Hz)
		1 0 1 0 Fixed frequency 10 (default 45 Hz)
		1 0 1 1 Fixed frequency 11 (default 50 Hz)
		1 1 0 0 Fixed frequency 12 (default 55 Hz)
		1 1 0 1 Fixed frequency 13 (default 60 Hz)
		1 1 1 0 Fixed frequency 14 (default 65 Hz)
		1 1 1 1 With active trip: Fault acknowledge (1) With no trip: OFF2 (2)

(1) The AS-i specification mandates the simultaneous use of 'Motor Left' and 'Motor Right' as fault acknowledge, particularly if there is no spare input available for this function.
 (2) If no fault is active then simultaneous operation of 'Motor Left' and 'Motor Right' constitutes a process image error. In this state both the inverter motor outputs and the motor holding brake outputs are inactive, causing the motor to coast to a halt and engaging the motor holding brake in exactly the same way as an OFF2 command. This state is maintained until both 'Motor Left' and 'Motor Right' are deactivated at the same time.

PKW mechanism for parameter transfer

A single message type is used which contains the parameter number to be read or written. The structure of the message is based on the PKW protocol as used in USS communications.

Structure

The basic structure of the PKW is shown in the figure below. it consists of two words of metadata followed by parameter data s required. As required by AS-i, all transfers are initiated by the AS-i master and where appropriate, responded to by the slave.



Figure 6-34 PKW component structure

The PKE consists of two fields. Bits 12 - 15 contain the request identifier (AK) as shown in the tables below. In this structure, parameter numbers are paged. Bits 10 - 0 of the PKE comprise the parameter number within a page of 2000 parameters; the page is defined in bits 10 - 15 of the IND word as shown in the figure below.

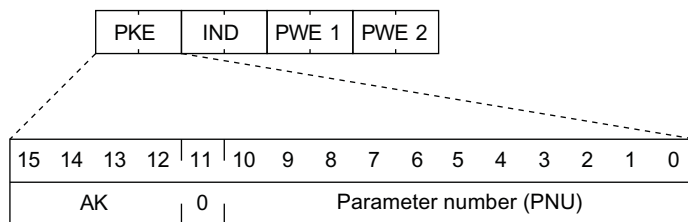

Figure 6-35 PKE component structure

The request ID defines whether the parameter is to be read or written and also the data type of the value being transferred. In addition it is possible to choose whether parameters are written permanently to EEPROM or only to volatile memory. In order to maximise compatibility with the USS protocol the task ID is retained in full.

Table 6- 62 Request IDs from master to slave

Request Identifier	Description	Response identifier	
		Positive	Negative
0	No request	0	7/8
1	Request parameter value	1/2	7/8
2	Modify parameter value (word)	1	7/8
3	Modify parameter value (double word)	2	7/8
4	Request descriptive element	3	7/8
6	Request parameter value (array)	4/5	7/8
7	Modify parameter value (array, word)	4	7/8
8	Modify parameter value (array, double word)	5	7/8
9	Request number of array elements	6	7/8
11	Modify parameter value (array, double word) and store in EEPROM	5	7/8
12	Modify parameter value (array, word) and store in EEPROM	4	7/8
13	Modify parameter value (double word) and store in EEPROM	2	7/8
14	Modify parameter value (word) and store in EEPROM	1	7/8

In general a PKW request results in a response from the slave. The response ID in the slave response has different meanings from those in the master message and in particular includes an error identifier which indicates that the first word of the PWE in the response contains an error code.

Table 6- 63 Response IDs from slave to master

Response Identifier	Description
0	No response
1	Transfer parameter value (word)
2	Transfer parameter value (double word)
3	Transfer descriptive element
4	Transfer parameter value (array word)
5	Transfer parameter value (array double word)
6	Transfer number of array elements
7	Cannot process request, task cannot be executed (with error number as describe in table below)

6.11 Operation in fieldbus systems

Table 6- 64 PKW error codes

Error code	Description	Errors set by task
0	Illegal PNU (illegal parameter number; parameter number not available). PKW1=0, PKW2=next PNU, PKW3=previous PNU.	1 to 15
1	Parameter value cannot be changed (because parameter is read-only)	2,3,7,8 or 11 to 14
2	Lower or upper limit violated (limit exceeded)	2,3,7,8 or 11 to 14
3	Erroneous sub-index. Note: not valid for task 4 "Getting parameter description". If the parameter in the drive is not an array, the drive will reply with this error only if the index is > 1. For index 0 or 1 the task will be executed. The response ID is then 4 or 5.	4,6,7,8,11, or 12
4	No array. Note: If the parameter in the drive is not an array, the drive will reply with this error only if the index is > 1. For index = 0 or index = 1 the task will be executed. The response ID is then = 4 or 5.	6,7,8,11, or 12
5	Parameter type is wrong/ incorrect data type.	2, 3, 7, 8 or 11 to 14
6	Setting not allowed (parameter value can only be reset to zero).	2, 3, 7, 8 or 11 to 14
7	Description cannot be changed; a PBEelement is not changeable and can only be read.	5
8	PPO write, requested in the IR, not available.	(PROFIdrive 2.0 only)
9	Descriptive data not available.	
10	Access group incorrect.	
11	No parameter change rights. See parameter p0927. Must have status as master control.	
12	Password incorrect.	
13	Text cannot be read in cyclic transmission.	
14	Name cannot be read in cyclic transmission.	
15	Text array is not available.	15
16	PPO write missing.	(PROFIdrive 2.0 only)
17	Drive operating state does not permit the set task at the moment.	2, 3, 7, 8 or 11 to 14
18	Other error	
19	Data cannot be read in cyclic transfer	
20	Change request for a value which is between the lower and the upper limit, but there are other reasons why the change request is not allowed; it is a parameter with defined single values.	
101	Parameter deactivated at the moment; parameter has no function in the present state of the drive converter.	1 to 15
102	Reply does not fit into buffer; depends on the number of PKW and the maximum net data length of the drive. Dependent on the number of PKW and the maximum net data length in the drive.	
104	Parameter value not permissible. The parameter value does not have an assigned function in the drive converter or cannot be accepted at the instant of the change for internal reasons (although it is within the limits) or the expert level has not been set or the value is not within the selection list. [PKW1 = 104, PKW2 = next value]	2, 3, 7, 8 or 11 to 14
105	Parameter is indexed	
106	Request is not implemented/task not supported	5,10 or 15
109	PKW request access timeout or number of retries is exceeded or wait for response from CPU side.	
110	Parameter value cannot be changed (because parameter is Locked).	

Error code	Description	Errors set by task
200	Modified lower limit exceeded.	2, 3, 7, 8 or 11 to 15
201	Modified upper limit exceeded.	2, 3, 7, 8 or 11 to 15
202	No display on the operator panel. Parameter must be hidden on the operator panel.	1 to 15
203	No display on the operator panel. Parameter must be hidden on the operator panel.	1 to 15
204	The available access authorization (i.e. level) does not cover modification of parameter (similar to 11 but used in combination with the secret password parameter).	1 to 15
210 - 214	Operator panel error codes; 210 = insufficient storage space in operator panel 211 = storage block cannot be found 212 = invalid block type for operation 213 = error in command arguments 214 = special operation failed	
300	Array elements differ.	

IND components

The IND word contains two pieces of information. The first is the page number of the parameter to be accessed. The page is stored in bits 10-15 of the IND word in reverse format, i.e. bit 15 is the least significant bit of the page number. As an example, consider the following:

Parameter 3900:3900 = 1 x 2000 + 1900PP = binary 100000 = 1 PNU = 1900

Parameter 4100:4100 = 2 x 2000 + 100PP = binary 010000 = 2 PNU = 100

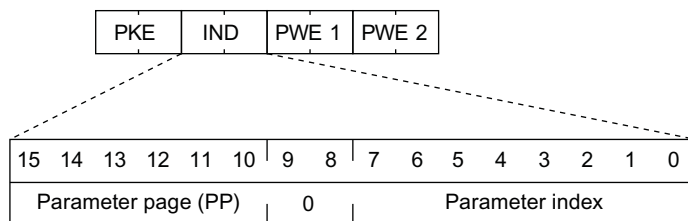

Figure 6-36 IND component structure

The other part of the IND word is the parameter index. For tasks involving arrays, this byte determines the part of the array to be accessed as shown below.

Table 6- 65 IND parameter index

Parameter index	Action
$0 \leq \text{IDX} \leq 254$	Access element IDX
$\text{IDX} = 255$	Access entire array

PWE components

The PWE part of the PKW message contains the parameter data. If the current PKW transfer requires no parameter data the PKE may be of zero length, otherwise it is arranged as one or more words. Data of length shorter than that available is packed in the PKE as shown in the figure below. When a complete array is transferred the format below is repeated as many times as required.

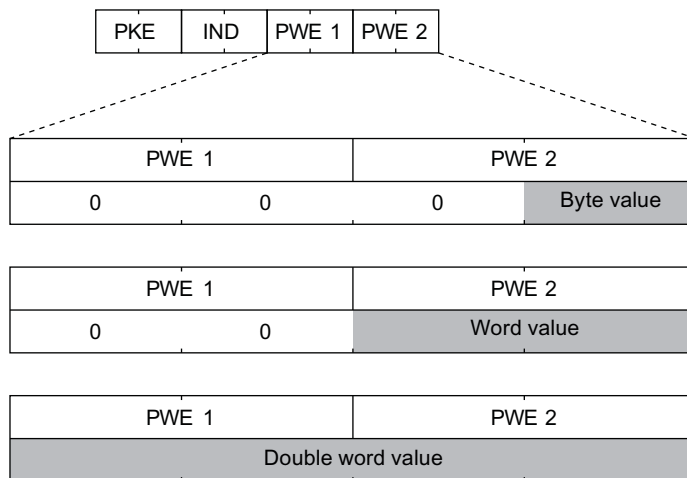

Figure 6-37 PWE component structure

Serial data transfer

The CTT2 protocol allows both cyclic and acyclic serial data to be transferred between master and slave. The commands implemented to achieve this are as shown in the table below.

Table 6- 66 CCT2 commands

Code (dec)	Code (hex)	Command/Response	Followed by
0	0x00	Read cyclic data from slave	4 byte PWE data
1	0x01	Write cyclic data to slave	4 byte PWE data
16	0x10	Standard read request	Index, length
80	0x50	Standard read response ok	Data
144	0x90	Standard read response error	Standard error code
17	0x11	Standard write request	index, length, data
81	0x51	Standard write response ok	
145	0x91	Standard write response error	Standard error code
18	0x12	Vendor specific read request	index, length
82	0x52	Vendor specific read response ok	data
146	0x92	Vendor specific read response error	error object
19	0x13	Vendor specific write request	Index, length, data
83	0x53	Vendor specific write response ok	
147	0x93	Vendor specific write response error	error object
29	0x1D	Vendor specific exchange request	index, read length, write length, write data
93	0x5D	Vendor specific exchange response ok	read data
157	0x9D	Vendor specific exchange response error	error object

CTT2 Error Codes

In the event that an acyclic request cannot be successfully responded to the following standard error codes are used.

Table 6- 67 Standard error codes

Error code	Description
0	no error
1	Illegal index
2	Illegal length
3	request not implemented
4	busy (request was not executed completely within time frame; try again later)
5	last acyclic request not acknowledged
6	Illegal sub index
7	Command "selective read request" is missing

Vendor specific response errors contain an error object. This consists of the appropriate standard error code followed by up to four bytes of optional further data. Inverters will not use the optional extra data and so will transmit an error object of only one byte in length.

Cyclic Data Transfer

The CTT2 cyclic data stream allows four bytes in each direction to be transferred on a regular basis between master and slave. The message between master and slave is 5 bytes in each direction, first the code byte (00 or 01 depending on direction) and then the four data bytes. Four bytes is sufficient for any single value parameter to be transferred but where the parameter to be transferred is of a type shorter than four bytes the data is padded as described in the figure below.

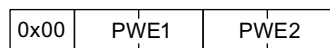

Cyclic transfer - slave to master

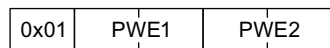

Cyclic transfer - master to slave

Figure 6-38 Cyclic data transfer

In the inverter the four bytes from the master appear in read only parameter rxxxx and the four bytes to the master are the value of the parameter pointed to by Pyyyy.

Pxxxx is not connected to any function by default but can be connected to any BiCo connector input as required – e.g. setting the value of P1070 to xxxx would connect the main inverter setpoint to the AS-i cyclic data from the master.

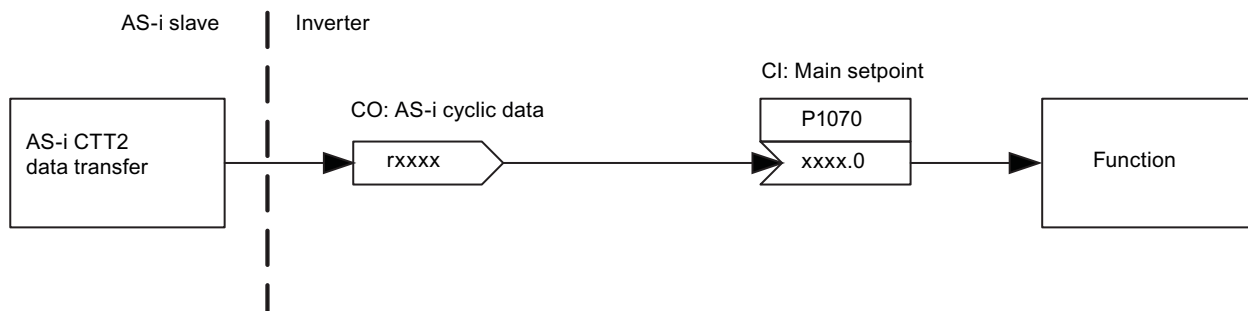

Figure 6-39 Cyclic data output

Pyyyy is a BiCo connector input and has a value by default of 27. This means that, by default, it is connected to P27 which is the filtered value of motor output current. Setting Pyyyy to the number of any other parameter which is a valid BiCo data source will make the value of that parameter appear in the AS-i cyclic data to the master.

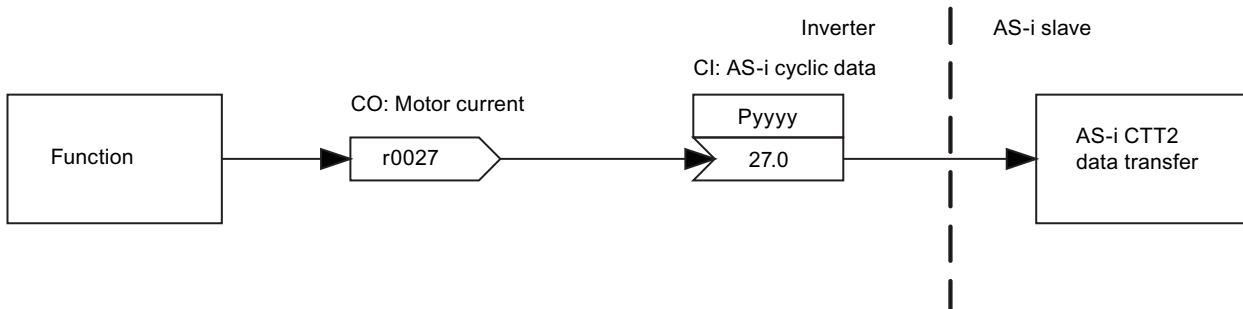

Figure 6-40 Cyclic data input

Standard Acyclic Data Transfer

Mandatory standard acyclic transfers are supported. These are ID read request and Diagnostic read request. Since the inverter will always send and receive two words of cyclic binary data, the last byte of the request is 0xBB.

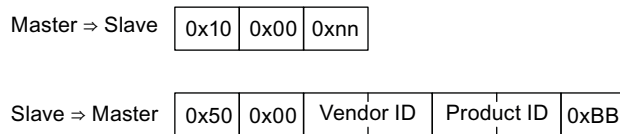

Figure 6-41 Standard ID read request and response

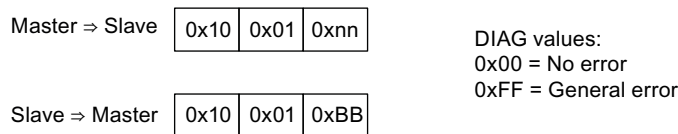

Figure 6-42 Standard diagnostic request and response

All other standard acyclic transfer requests will result in a 'request not implemented' error response.

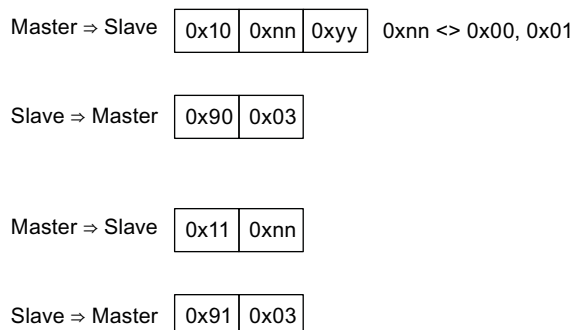

Figure 6-43 Unrecognised standard acyclic request and response

Vendor Specific Acyclic Data Transfer

Datasets

The standard method for inverter parameter transfer is dataset 47 which allows a flexible bidirectional transfer of data to and from a large number of parameters. This is the method used in AS-i inverters, no other datasets are recognized.

Since the PKW transfer method itself specifies the direction in which data is transferred, it is possible to perform all parameter transfers using the data exchange request/response. Data read and write requests are included primarily to reduce the amount of data needed to be exchanged when repeatedly reading the same parameter or when carrying out parameter writes.

Data Read

A data read request results in the transfer of the last parameter data accessed (either by a write or a transfer request), i.e. the behaviour is as if a PKW read command had been issued for the parameter last accessed. If no previous write or transfer request has been made the parameter to be transferred is not defined. Note that unlike other inverter communication bus implementations, the parameter data is not cached and so repeated read requests will always result in the most current available data being transferred.

Functions

6.11 Operation in fieldbus systems

Telegram structure

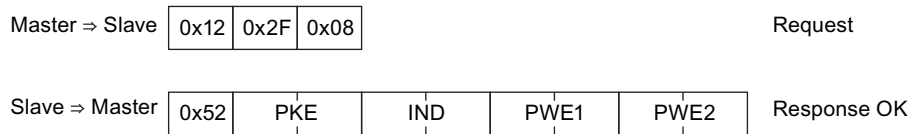

Example data block 3 - returned value from AS-i slave

Address	Name	Type	Initial value	Comment
0.0		STRUCT		
+0.0	Byte_Count	BYTE	B#16#0	number of bytes in reply message
+1.0	Status	BYTE	B#16#0	Return status of message
+2.0	PKE	DWORD	DW#16#0	parameter number & index
+6.0	PWE	DWORD	DW#16#0	parameter value
+10.0	Dummy	DWORD	DW#16#FFFFFF	Dummy double word for extra data sent by function block
=14.0		END_STRUCT		

Example data block 4 - parameter read command

Address	Name	Type	Initial value	Comment
0.0		STRUCT		
+0.0	Async	BYTE	B#16#44	Instruct AS-i link advanced to perform a CTT2 transfer
+1.0	Addr	BYTE	B#16#1	Slave address
+2.0	Length	BYTE	B#16#3	Length of CTT2 message
+3.0	Command	BYTE	B#16#12	vendore specific read
+4.0	Dataset	BYTE	B#16#2F	Dataset 47 for all inverter transactions
+5.0	LEN	BYTE	B#16#8	8 byte PKW transfer (double word value)
=6.0		END_STRUCT		

Example read request utilizing data block 3 and data block 4

```

Network: 2
Read PKW from G110D

AN      "Dummy Switch"
=       L      0.0
BLD    103
A       "Dummy Switch"
=       L      0.1
BLD    103
AN      I      40.0
A       I      40.2
JNB     _002
CALL   "ASi_3422"
ACT     :=L0.0
STARTUP:=L0.1
LADDR  :=W#16#7
SEND   :=P#DB4.DBX0.0 BYTE 6
RECV   :=P#DB3.DBX0.0 BYTE 8
DONE   :=Q40.0
ERROR  :=Q40.1
STATUS :=MD22
_002:  NOP  0
    
```

Figure 6-44 Parameter read request and response

Data Write

A data write request transfers the specified parameter data to the inverter. Since the normal PKW response is not sent, in the event that the PKW command is not successfully completed the inverter replies with an error response containing a standard error byte of 'no error' and a further word value containing the error code.

This request only makes sense for a PKW write command.

Telegram structure

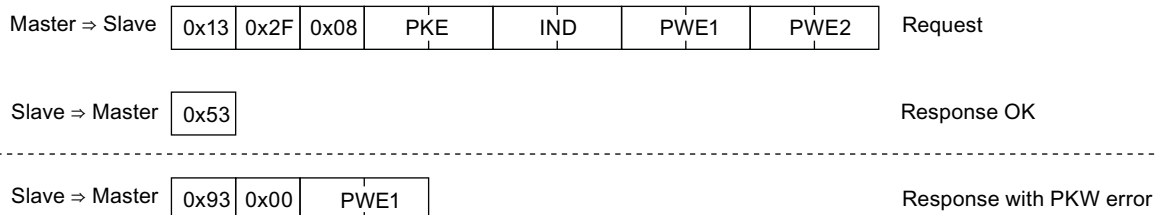

Example data block 3 - parameter write command

Address	Name	Type	Initial value	Comment
0.0		STRUCT		
+0.0	Command	BYTE	B#16#44	Instruct AS-i link advanced to perform a CTT2 transfer
+1.0	Address	BYTE	B#16#1	Slave address
+2.0	CTT2_Len	BYTE	B#16#B	Length of CTT2 Message
+3.0	CTT2_Command	BYTE	B#16#13	CTT2 vendor specific write
+4.0	Dataset	BYTE	B#16#2F	Dataset 47 for all inverter transactions
+5.0	command_Len	BYTE	B#16#8	8 byte PKW transfer (double word value)
+6.0	PKE	DWORD	DW#16#1018000	Parameter number & index
+10.0	PWE	DWORD	DW#16#0	Parameter value
=14.0		END_STRUCT		

Example data block 3 - returned value from AS-i slave

Address	Name	Type	Initial value	Comment
0.0		STRUCT		
+0.0	Byte_Count	BYTE	B#16#0	number of bytes in reply message
+1.0	Status	BYTE	B#16#0	Return status of message
+2.0	PKE	DWORD	DW#16#0	parameter number & index
+6.0	PWE	DWORD	DW#16#0	parameter value
+10.0	Dummy	DWORD	DW#16#FFFFFF	Dummy double word for extra data sent by function block
=14.0		END_STRUCT		

Example read request utilizing data block 2 and data block 3

```

Network: 1
Write PKW to G110D

    AN    "Dummy Switch"
    =     L      0.0
    BLD  103
    A     "Dummy Switch"
    =     L      0.1
    BLD  103
    A     I      40.0
    AN    I      40.2
    JNB   _001
    CALL  "ASi_3422"
    ACT   :=L0.0
    STARTUP:=L0.1
    LADDR :=W#16#7
    SEND  :=P#DB2.DBX0.0 BYTE 14
    RECV  :=P#DB3.DBX0.0 BYTE 10
    DONE  :=Q40.0
    ERROR :=Q40.1
    STATUS :=MD22
_001: NOP 0
    
```

Figure 6-45 Parameter write request and response

Data Exchange

A data exchange request first transfers parameter data to the inverter and then transfers the reply back to the master. This request is the 'normal' method by which PKW transfers take place in other protocols such as USS or Profibus.

6.11 Operation in fieldbus systems

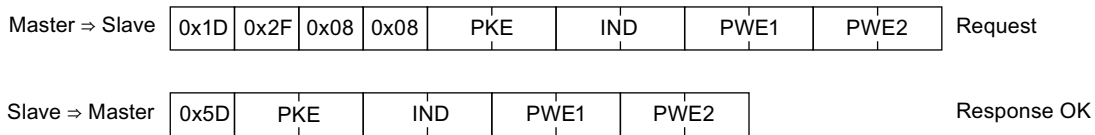

Figure 6-46 Parameter exchange request and response

Error Responses

As with acyclic standard requests, any vendor specific requests other than those listed above, including requests for any data set other than 47, will result in the appropriate 'request not implemented' error response.

In the event that the inverter is unable to service an acyclic vendor specific request within the time required by the AS-i standard, it will instead respond with error code 4, 'busy'. Since one second is allowed between the request and response it is extremely unlikely that this code will ever be used.

6.11.1.5 Step 7 example conveyor program

Overview of example

This example, although not specific to the functionality of the SINAMICS G110D Inverter gives an overview of the type of scripting that can be used to generally control a conveyor system.

The Step 7 example shows the transfer of signal states utilizing block parameters. The conveyor belt control is located in a function block and all inputs and outputs are routed using block parameters, so that the function block can be used repeatedly.

All binary addresses that were inputs have become input parameters, all outputs have become output parameters and all memory bits have become static local data. Names have also been changed because only alphanumeric characters and the underscore are permissible for block-local variables.

Main program

The structure of the main program allows the various functions that have been defined for this application to be called easily and efficiently.

Basically it allows the conveyor belt to be moved; monitor the items on the conveyor and their position and control the process over a number of conveyor segments.

The main program is given in the figure below.

```

Block: OB1 Main program
Calling the blocks for the Conveyor example
You can choose between:
- "Select_FC" which calls only the functions
- "Select_FB" which calls the function block individually
- "Select_L" which calls the function block "Conveyor_belt" with all
  belt controllers as local instances

Network: 1 Calling the function "Belt_control"

A "Select_FC" 13.5 -- Selection for FC 11 and FC 12 call
AN "Select_FB" 13.6 -- Selection for FB 21 and FB 22 call
AN "Select_L" 13.7 -- Selection for FB 20 call with local instances
JCN M1
CALL "Belt_control" FC11 -- Control of the conveyor belt

Network: 2 Calling the function "Counter_control"

CALL "Counter_control" FC12 -- Counter and monitor control for parts

Network: 3 Calling the function "Conveyor_belt"

M1: AN "Select_FC" 13.5 -- Selection for FC 11 and FC 12 call
A "Select_FB" 13.6 -- Selection for FB 21 and FB 22 call
AN "Select_L" 13.7 -- Selection for FB 20 call with local instances
JCN M2
CALL "Conveyor_belt" , "Belt_data1" FB21 / DB21 -- Conveyor belt controller / Data for conveyor belt 1
Start := "Start" 10.3 -- Start conveyor belt
Continue := "Continue" 10.4 -- Acknowledgement that parts have been removed
Basic_st := "Basic_st" 10.0 -- Set controller to the basic state
Man_on := "Man_on" 10.1 -- Switch on conveyor belt motors
Stop := "/Stop" 10.2 -- Stop conveyor belt motors (zero active)
End_of_belt := "Light_barrier1" 11.0 -- "End of belt" sensor signal conveyor belt 1
Mfault := "/Mfault1" 12.0 -- Motor protection switch conveyor belt 1 (zero active)
Readyload := "Readyload" Q4.0 -- Load new parts onto belt
Ready_rem := "Ready_rem" Q4.1 -- Remove parts from belt
Belt_mot_on := "Belt_mot1_on" Q5.0 -- Switch on belt motor for conveyor belt 1

CALL "Conveyor_belt" , "Belt_data2" FB21 / DB22 -- Conveyor belt controller / Data for conveyor belt 2
Start := "Start" 10.3 -- Start conveyor belt
Continue := "Continue" 10.4 -- Acknowledgement that parts have been removed
Basic_st := "Basic_st" 10.0 -- Set controller to the basic state
Man_on := "Man_on" 10.1 -- Switch on conveyor belt motors
Stop := "/Stop" 10.2 -- Stop conveyor belt motors (zero active)
End_of_belt := "Light_barrier2" 11.1 -- "End of belt" sensor signal conveyor belt 2
Mfault := "/Mfault2" 12.1 -- Motor protection switch conveyor belt 2 (zero active)
Readyload := "Readyload" Q4.0 -- Load new parts onto belt
Ready_rem := "Ready_rem" Q4.1 -- Remove parts from belt
Belt_mot_on := "Belt_mot2_on" Q5.1 -- Switch on belt motor for conveyor belt 2

Network: 4 Calling the function block "Parts_counter"

CALL "Parts_counter" , "CountDat" FB22 / DB29 -- Counter control and monitor / Data for parts counter
Set := "Set" 10.7 -- Set counter, activate monitor
Acknowledge := "Acknowledge" 10.6 -- Acknowledge fault
Light_barrier := "Light_barrier1" 11.0 -- "End of belt" sensor signal conveyor belt 1
Count := "Count" C1 -- Counter for parts
Quantity := "Quantity" MW4 -- Number of parts
Tim := "Monitor" T1 -- Timer function for monitor
Dura1 := "Dura1" MW6 -- Monitoring time for light barrier covered
Dura2 := "Dura2" MW8 -- Monitoring time for light barrier not covered
Finished := "Finished" Q4.2 -- Number of parts reached
Fault := "Fault" Q4.3 -- Monitor tripped

Network: 5 Calling the function block "Feed"

M2: AN "Select_FB" 13.6 -- Selection for FB 21 and FB 22 call
AN "Select_FC" 13.5 -- Selection for FC 11 and FC 12 call
A "Select_L" 13.7 -- Selection for FB 20 call with local instances
JCN End
CALL "Feed" , "FeedDat" FB20 / DB20 -- Feed with several belts / Data for feeding parts
Start := "Start" 10.3 -- Start conveyor belt
Removed := "Continue" 10.4 -- Acknowledgement that parts have been removed
Man_start := "Man_on" 10.1 -- Switch on conveyor belt motors
Stop := "/Stop" 10.2 -- Stop conveyor belt motors (zero active)
Reset := "Basic_st" 10.0 -- Set controller to the basic state
Count := "Count" C1 -- Counter for parts
Quantity :=
Tim := "Monitor" T1 -- Timer function for monitor
Dura1 :=
Dura2 :=
Load := "Readyload" Q4.0 -- Load new parts onto belt
Remove := "Ready_rem" Q4.1 -- Remove parts from belt

Network: 6 Block end

End: BE

```

Figure 6-47 Example conveyor application script - main program

Control of several conveyor belts

The program in the figure below, controls 4 conveyor belts simultaneously, with each belt being monitored for the position of the belt and any faults conditions that occur. On completion of a belt cycle, the number of items of the belt is recorded.

```

Block: FB20   Control of several conveyor belts
Example of local instances (declaration, calls)

Network: 1   Initializing the common signals

A   #Man_start
=   #Belt1.Man_on
=   #Belt2.Man_on
=   #Belt3.Man_on
=   #Belt4.Man_on

A   #Stop
=   #Belt1.Stop
=   #Belt2.Stop
=   #Belt3.Stop
=   #Belt4.Stop

A   #Reset
=   #Belt1.Basic_st
=   #Belt2.Basic_st
=   #Belt3.Basic_st
=   #Belt4.Basic_st

Network: 2   Calling the conveyor belt controllers

CALL #Belt1
Start      :=#Start
Continue   :=
Basic_st   :=
Man_on     :=
Stop       :=
End_of_belt:= "Light_barrier1" I1.0      -- "End of belt" sensor signal conveyor belt 1
Mfault     := "/Mfault1" I2.0           -- Motor protection switch conveyor belt 1 (zero active)
Readyload  := #Load
Ready_rem  :=
Belt_mot_on:= "Belt_mot1_on" Q5.0      -- Switch on belt motor for conveyor belt 1

A   #Belt2.Readyload
=   #Belt1.Continue
A   #Belt1.Ready_rem
=   #Belt2.Start

CALL #Belt2
Start      :=
Continue   :=
Basic_st   :=
Man_on     :=
Stop       :=
End_of_belt:= "Light_barrier2" I1.1      -- "End of belt" sensor signal conveyor belt 2
Mfault     := "/Mfault2" I2.1           -- Motor protection switch conveyor belt 2 (zero active)
Readyload  :=
Ready_rem  :=
Belt_mot_on:= "Belt_mot2_on" Q5.1      -- Switch on belt motor for conveyor belt 2

A   #Belt3.Readyload
=   #Belt2.Continue
A   #Belt2.Ready_rem
=   #Belt3.Start

CALL #Belt3
Start      :=
Continue   :=
Basic_st   :=
Man_on     :=
Stop       :=
End_of_belt:= "Light_barrier3" I1.2      -- "End of belt" sensor signal conveyor belt 3
Mfault     := "/Mfault3" I2.2           -- Motor protection switch conveyor belt 3 (zero active)
Readyload  :=
Ready_rem  :=
Belt_mot_on:= "Belt_mot3_on" Q5.2      -- Switch on belt motor for conveyor belt 3

A   #Belt4.Readyload
=   #Belt3.Continue
A   #Belt3.Ready_rem
=   #Belt4.Start

CALL #Belt4
Start      :=
Continue   := #Removed
Basic_st   :=
Man_on     :=
Stop       :=
End_of_belt:= "Light_barrier4" I1.3      -- "End of belt" sensor signal conveyor belt 4
Mfault     := "/Mfault4" I2.3           -- Motor protection switch conveyor belt 4 (zero active)
Readyload  :=
Ready_rem  := #Remove
Belt_mot_on:= "Belt_mot4_on" Q5.3      -- Switch on belt motor for conveyor belt 4

Network: 3   Call for counting and monitoring

CALL #Check
Set         := "Set" I0.7               -- Set counter, activate monitor
Acknowledge := "Acknowledge" I0.6       -- Acknowledge fault
Light_barrier:= "Light_barrier1" I1.0    -- "End of belt" sensor signal conveyor belt 1
Count       := #Count
Quantity    := #Quantity
Tim         := #Tim
Dura1      := #Dura1
Dura2      := #Dura2
Finished    := "Finished" Q4.2          -- Number of parts reached
Fault       := "Fault" Q4.3            -- Monitor tripped

Network: 4   Block end
    
```

BE

Figure 6-48 Example conveyor application script - control of several conveyor belts

Controlling a conveyor belt using block parameters

The program in the figure below starts and stops the conveyor belt and monitors the belt of faults. When parts reach the end of the conveyor belt, the belt is stop so the items can be removed. If a fault condition occurs, the belt will be stop until the fault is rectified. The program utilized block parameters of an elementary data type.

```

Block: FB21 Controlling a conveyor belt
Example of binary logic operations and memory functions
Example of block parameters of elementary data types

Network: 1 Load parts
This network generates the command "Load" that initiates transport
of the parts to the end of the belt.
A #Start //Start conveyor belt
S #Load
O #End_of_belt //Parts have reached end of belt
O #Basic_st
ON #MfaulT //Motor protection switch (zero active)
R #Load

Network: 2 Parts ready for removal
When the parts have reached the end of the belt, they are ready for removal
A #Load //When the end of the belt has been reached
FN #EM_Loa_N //"Load" is reset.
S #Ready_rem //The parts are then "ready for removal"
A #Remove
FP #EM_Rem_P //The parts are removed
O #Basic_st
ON #MfaulT
R #Ready_rem

Network: 3 Remove parts
The command "Remove" initiates removal of the parts from the belt.
A #Continue //Conveyor belt switched on again
S #Remove
ON #End_of_belt //Parts leave the end of the belt
O #Basic_st
ON #MfaulT //Motor protection switch (zero active)
R #Remove

Network: 4 Belt ready for loading
The conveyor belt is ready for loading when the parts have left the belt
A #Remove
FN #EM_Rem_N //Parts have left the belt
O #Basic_st
S #Readyload //Belt is empty
A #Load
FP #EM_Loa_P //Conveyor belt is started
ON #MfaulT
R #Readyload

Network: 5 Control belt motor
In this network, the belt motor is switched on and off
A(
O #Load //Load parts onto belt
O #Remove //Remove parts from belt
O #Man_on //Start with "Man_on" (non-latching)
)
A #Stop //Stop and motor fault prevent
A #MfaulT //the belt motor from running
= #Belt_mot_on

Network: 6 Block end
BE
    
```

Figure 6-49 Example conveyor application script - controlling a conveyor belt

In the figure below, a method of accomplishing the control of a conveyor belt without the use of block parameters is shown.

6.11 Operation in fieldbus systems

```

Block: FC11 Control of a conveyor belt
Example of binary logic operations and memory functions, without block
parameters

Network: 1 Load parts
This network generates the command "Load" that initiates transport of parts
to the end of the belt.

A "Start" //Start conveyor belt I0.3 -- Start conveyor belt
S "Load" -- Load parts command M2.0
O "Light_barrier1" //Parts have reached end of belt I1.0 -- "End of belt" sensor
signal conveyor belt 1
O "Basic_st" I0.0 -- Set controller to the
basic state
ON "/Mfault1" //Motor protection switch (zero active) I2.0 -- Motor protection switch
conveyor belt 1 (zero active)
R "Load" M2.0 -- Load parts command

Network: 2 Parts ready for removal
When the parts have reached the end of the belt, they are ready for removal.

A "Load" //When the end of the belt has been reached, M2.0 -- Load parts command
FN "EM_Loa_N" //Load" is reset. M2.4 -- Edge memory bit for neg
ative edge of "Load"
S "Ready_rem" //The parts are then "ready for removal" Q4.1 -- Remove parts from belt
A "Remove" M2.1 -- Remove parts command
FP "EM_Rem_P" //The parts are removed M2.3 -- Edge memory bit for pos
itive edge of "Remove"
O "Basic_st" I0.0 -- Set controller to the b
asic state
O "/Mfault1" I2.0 -- Motor protection switch
conveyor belt 1 (zero active)
R "Ready_rem" Q4.1 -- Remove parts from belt

Network: 3 Remove parts
The command "Remove" causes the parts to be transported from the conveyor belt.

A "Continue" //Switch belt back on I0.4 -- Acknowledgement that
parts have been removed
S "Remove" M2.1 -- Remove parts command
ON "Light_barrier1" //Parts leave the belt I1.0 -- "End of belt" sensor
signal conveyor belt 1
O "Basic_st" I0.0 -- Set controller to the
basic state
ON "/Mfault1" //Motor protection switch (zero active) I2.0 -- Motor protection switch
conveyor belt 1 (zero active)
R "Remove" M2.1 -- Remove parts command

Network: 4 Belt ready for loading
The conveyor belt is ready for loading when the parts have left the belt.

A "Remove" M2.1 -- Remove parts command
FN "EM_Rem_N" //Parts have left the belt M2.2 -- Edge memory bit for neg
ative edge of "Remove"
O "Basic_st" I0.0 -- Set controller to the b
asic state
S "Readyload" //Belt is empty Q4.0 -- Load new parts onto bel
t
A "Load" M2.0 -- Load parts command
FP "EM_Loa_P" //Belt is started M2.5 -- Edge memory bit for pos
itive edge of "Load"
ON "/Mfault1" I2.0 -- Motor protection switch
conveyor belt 1 (zero active)
R "Readyload" Q4.0 -- Load new parts onto bel
t

Network: 5 Control belt motor
The belt motor is switched on and off in this network.

A(
O "Load" //Load parts onto belt M2.0 -- Load parts command
O "Remove" //Remove parts from belt M2.1 -- Remove parts command
O "Man_on" //Start with "Man_on" (non-latching) I0.1 -- Switch on conveyor bel
t motors
)
A "/Stop" //Stop and motor fault prevent I0.2 -- Stop conveyor belt mot
ors (zero active)
A "/Mfault1" //the motor from running I2.0 -- Motor protection switc
h conveyor belt 1 (zero active)
= "Belt_mot1_on" Q5.0 -- Switch on belt motor f
or conveyor belt 1

Network: 6 Block end

BE
    
```

Figure 6-50 Example conveyor script - control a conveyor belt without block parameters

Parts counter with monitor

This program is responsible for counting the actual items on the conveyor belt. This is accomplished using light barriers, which when the item passed the light barrier, the count of items is decreased by 1. A pre-assigned count value needs to be entered prior to the running of the conveyor system. When the count reaches '0', the conveyor belt is stopped.

```

Block: FB22  Parts counter with monitor
Example of timer and counter functions
Example of block parameters with parameter types

Network: 1  Counter control

A  #Light_barrier //When the light barrier is tripped
CD #Count         //count down by 1
A  #Set
L  #Quantity     //Pre-assignment of the count value
S  #Count
O  #Acknowledge
R  #Count
AN #Count        //When count value zero is reached,
=  #Finished     //output "Finished" signal

Network: 2  Activate monitor

A  #Light_barrier
FP #EM_LB_P     //Generation of pulse memory bit on
=  #PM_LB_P     //positive edge of the light barrier
A  #Light_barrier
FN #EM_LB_N     //Generation of pulse memory bit on
=  #PM_LB_N     //negative edge of the light barrier
A  #Set
FP #EM_ST_P
S  #Active      //Activate monitor
A  #Finished
A  #PM_LB_N
O  #Acknowledge
R  #Active      //Deactivate monitor

Network: 3  Monitor circuit

L  #Dura1
A  #Light_barrier //If the light barrier has "1", the jump
JC D1             //JC to D1 is executed and the accumulator
L  #Dura2         //contains "Dura1", otherwise, the
D1: A #Active     //accumulator contains "Dura2"
FP #EM_Ac_P      //If there is a positive edge at "Active"
O  #PM_LB_P      //or a positive edge at the LB
O  #PM_LB_N      //or a negative edge at the LB
SE #Tim          //the timer is (re)started
AN #Tim
A  #Active       //If the time has elapsed at "Active",
=  #Fault        //"Fault" is signaled

Network: 4  Block end

BE
    
```

Figure 6-51 Example conveyor application script - parts counter with monitor

In the figure below, a method of accomplishing the counting of items on the conveyor and monitoring the belt without the use of block parameters is shown.

```

Block: FC12  Parts counter with monitoring circuit
Example of timer and counter functions

Network: 1  Counter control

A  "Light_barrier1" //When light barrier is tripped          I1.0      -- "End of belt" sensor
CD "Count"          //decrement counter by 1                 C1         -- signal conveyor belt 1
A  "Set"            //                                         I0.7      -- Counter for parts
                                         monitor    -- Set counter, activate
L  "Quantity"      //Preset count with "Quantity"           MW4        -- Number of parts
S  "Count"         //                                         C1         -- Counter for parts
O  "Acknowledge"   //                                         I0.6      -- Acknowledge fault
R  "Count"         //When count reaches zero,                 C1         -- Counter for parts
AN "Count"         //output "Finished" signal                 C1         -- Counter for parts
=  "Finished"      //                                         Q4.2      -- Number of parts reach
                                         ed

Network: 2  Activate monitor

A  "Light_barrier1"          I1.0      -- "End of belt" sensor
FP "EM_LB_P"                //Generate pulse memory bit  M3.1      -- signal conveyor belt 1
=  #PM_LB_P                  //Edge memory bit for p
A  "Light_barrier1"         //on positive edge of light barrier
FN "EM_LB_N"                //Generate pulse memory bit  M3.2      -- Edge memory bit for n
=  #PM_LB_N                  //Edge memory bit for n
A  "Set"                     //on negative edge of light barrier
FP "EM_ST_P"                //Positive edge for set      M3.4      -- Edge memory bit for p
S  "Active"                  //Activate monitoring circuit M3.0      -- ositive edge of "Set"
A  "Finished"                //Counter and monitor a
=  #PM_LB_N                  ctive
O  "Acknowledge"            //Number of parts reach
R  "Active"                  //Deactivate monitoring circuit Q4.2
                                         ed

Network: 3  Monitor circuit

L  "Dura1"                  //If light barrier is "1"    MW6        -- Monitoring time for 1
A  "Light_barrier1"         //jump JC to D1 is executed and the I1.0      -- light barrier covered
JC D1                       //accumulator contains "Dura1", otherwise
L  "Dura2"                  //the accumulator contains "Dura2" MW8        -- Monitoring time for 1
D1: A  "Active"              //light barrier not covered M3.0      -- Counter and monitor a
FP "EM_Ac_P"                //If there is a positive edge at "Active" M3.3      -- ctive
O  #PM_LB_P                 //Edge memory bit for f
O  #PM_LB_N                 //or a positive edge at the light barrier, M3.0      -- or positive edge of "Monitor active"
SE "Monitor"                //or a negative edge at the light barrier,
AN "Monitor"                //the timer is started or retriggered.
A  "Active"                  T1         -- Timer function for mo
=  "Fault"                  //If time elapses while "Active",
                                         nitor
                                         T1         -- Timer function for mo
                                         nitor
                                         M3.0      -- Counter and monitor a
                                         ctive
                                         Q4.3      -- Monitor tripped

Network: 4  Block end

BE
    
```

Figure 6-52 Example conveyor script - parts counter and monitoring without block parameters

6.11.1.6 Example application

Commissioning the applications

The following information is provided to allow a simple conveyor application to be setup. The logic and control mechanism is provided by a PLC.

The conveyor section consists of three sensors:

- A: This sensor detects the arrival of an item on the conveyor.
- B: This sensor detects the item and signals the next section to start and be ready to receive an item. This requires two speeds, one for the normal movement of the load and a faster speed for the transfer between conveyor sections.
- C: This sensor detects the load leaving the conveyor section.

The sensors are directly connected to the Inverter to allow their individual status to be sent to the controlling PLC.

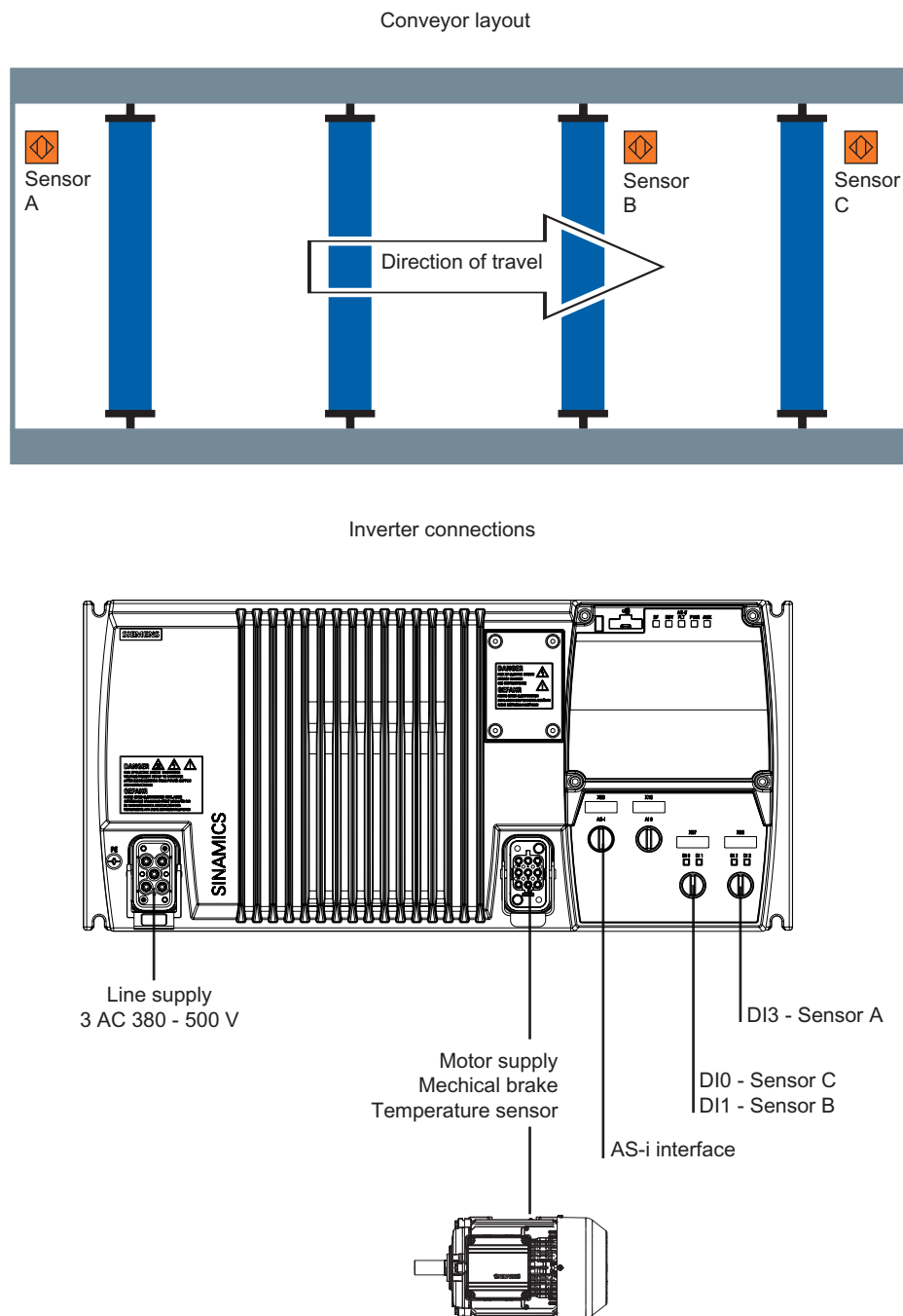

Figure 6-53 Example conveyor application

Application parameters

Using the "Expert List" mode in STARTER (as previously described) the following parameters should be modified as shown in the table below. Before setting the parameters listed below, you must wait until P3900 = 0.

In addition to the AS-i specific parameters discussed in the previous section the following parameters should be modified to allow the digital inputs to be read by the controlling PLC.

Table 6- 68 Conveyor application parameters

Parameter	Setting	Description
P0701 [0]	22	Digital input DI0 set to Quick Stop source 1 allowing DI0 to be used as Quick Stop input
P0971	1	Transfers parameter values from RAM to EEPROM

Example S7 script and ladder logic

The following is an example S7 script which the PLC will use to communicate with the Inverter.

```

Baustein:  FC2      Example application
-----
Network:  1      Start conveyor
-----
    U      "START"
    =      "G110D _ FAST"

Network:  2      Generate message occupied
-----
    U      "G110D _ DI3"
    FP     "EdgeDI3"
    S      "ConveyorOccupied"

Network:  3      Switch from FAST to SLOW
-----
    U      "G110D _ DI1"
    U      "NextConveyorOccupied"
    -      "G110D _ SLOW"

Network:  4      Wait for following conveyor
-----
    UN     "NextConveyorOccupied"
    =      "G110D _ QSdisable"

Network:  5      Generate message occupied
-----
    UN     "G110D _ DI0"
    FN     "EdgeDI0"
    R      "ConveyorOccupied"
    
```

Figure 6-54 Example S7 script

The following is an example ladder logic diagram.

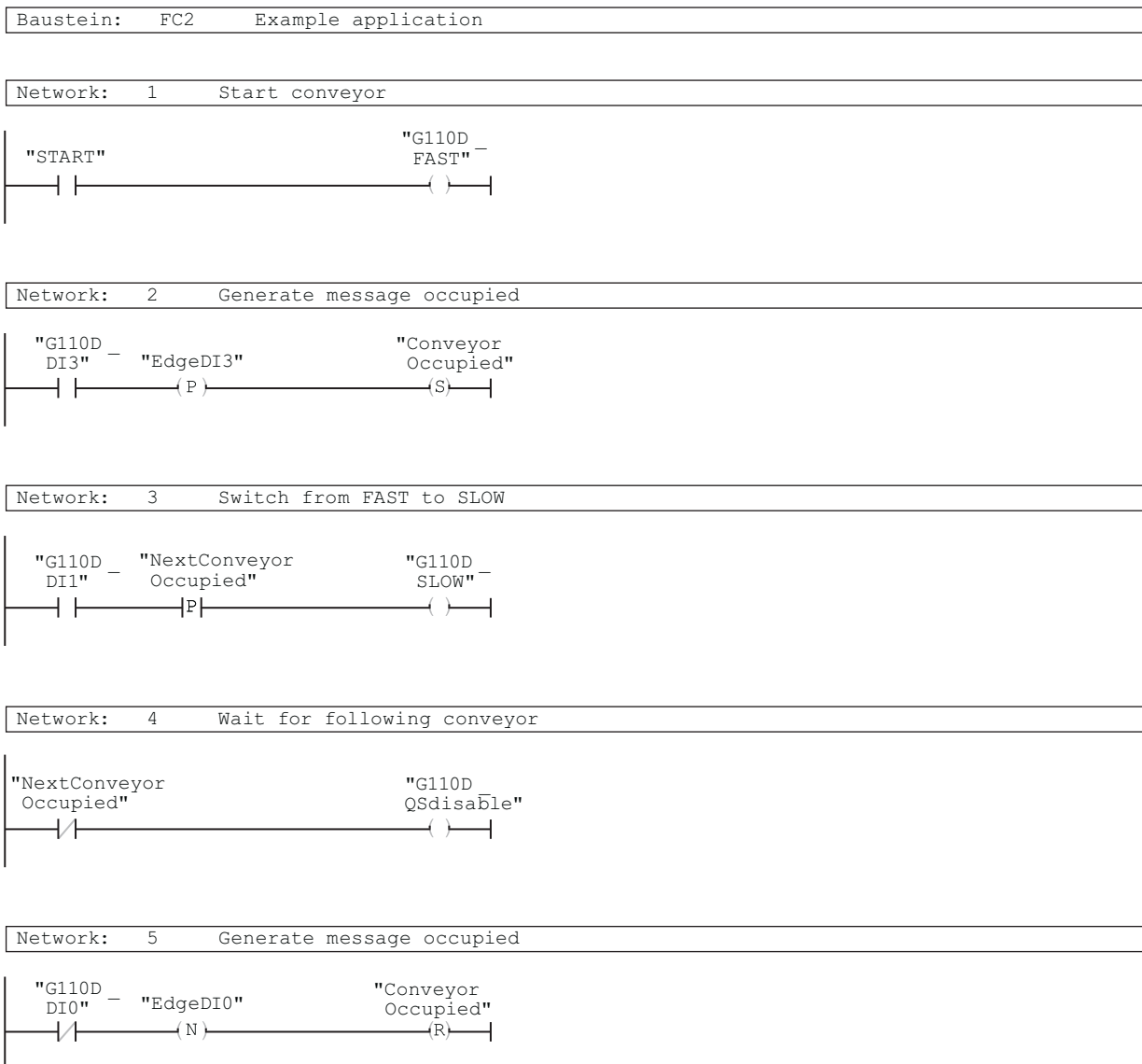

Figure 6-55 Example S7 ladder logic

Service and maintenance

7.1 Behaviour of the Inverter when replacing components

Replacing the Inverter

To ensure maximum plant availability, the Inverter can, when required, be replaced by a unit of the same type and the version without having to recommission the drive.

Replace the Inverter with the same type and the same version

- With automatic parameter download (without recommissioning the system)

The prerequisite in this case is that the Inverter is operated with a memory card and the setting P8458 = 1 or 2 (parameters are automatically downloaded from the memory card). The Inverter is parameterized using the automatic parameter download.

- With manual parameter download (standard commissioning)

Parameters are not automatically downloaded if there is no memory card or with the setting P8458 = 0. If a valid parameter set is available, then the Inverter is parameterized by manually downloading this parameter set (from the memory card, IOP or PC).

Note

A valid parameter set is a parameter set that matches the type and software release of the Inverter and that has been adapted to fit the particular application.

Replace an Inverter by the same type

- Same power rating

If you replace an Inverter by the same type and the same power, then re-parameterization is not required.

- Same format, higher power rating

If you replace an Inverter by one of the same type and the same format, however with a higher power rating, then re-parameterization is not absolutely necessary. However, it is possible that the open-loop control accuracy is therefore reduced.

- Lower power rating

If you replace an Inverter by one with the same type and with a lower power rating, then the Inverter must be re-commissioned.

Replacing different components or version

If you replace different components with different software releases, then the Inverter must always be re-commissioned.

Questions that can arise in conjunction with replacing components:

- How do I create a valid parameter set?
When commissioning, you can create a valid parameter set either using the commissioning software STARTER or using the IOP.
- Which options are available for saving a valid parameter set? You can save a valid parameter set either on the memory card or on the computer that you use for commissioning with STARTER.
- How do I load a valid parameter set into my frequency inverter?
From the memory card when the frequency inverter is powered-up or by manually downloading a parameters set either from the memory card or from the PC.

7.2 Replacing the Inverter

Replacing the Inverter

When replacing the Inverter, ensure that you use the correct replacement Inverter.

To replace the Inverter the following procedure should be performed:

1. Disconnect the Inverter from the power supply.
2. Wait at least 5 minutes to allow the Inverter to discharged all residual power.
3. Disconnect all cables and connections from the Inverter to be replaced.
 - There is no need to remove the M12 ASi branch nodes from the ASi-bus. The ASi-controller will recognize that the two slave nodes have been removed from the network. This will not interrupt the communications or other devices on the ASi network.
4. If a memory card has been used, remove it from the Inverter.
5. Remove the Inverter from its mounted position.
6. Mount the new Inverter, ensuring that if a memory card is used, it is fitted before mounting the Inverter.
7. Reconnect all the cables and ASi connections.
8. Switch-on the power to the Inverter.
9. The ASi-controller will automatically recognize the new slave nodes and assign them an appropriate address.
 - The Inverter contains two slave nodes, one is visible to the network, the other is hidden. When the first node is assigned an address, the second node becomes visible to the network. The second node is then assigned an appropriate address.
10. If required, manually download a valid parameter set.

7.3 Local/remote switch cover

Overview

 WARNING
Safety functions
The local/remote switch does not perform any safety function in accordance with the EU Machinery Directive (98/37/EC).

The local/remote switch cover has been designed to enable the user to take control of the Inverter and motor from the automated system. In the local mode, the user can precisely control the movement of the motor, for example, starting, stopping and inching the motor when fitting a new belt to a conveyor section.

The switch cover is an optional extra and can be ordered using the following order number: 6SL3555-0PL00-2AA0

The layout of the switch cover is shown in the figure below.

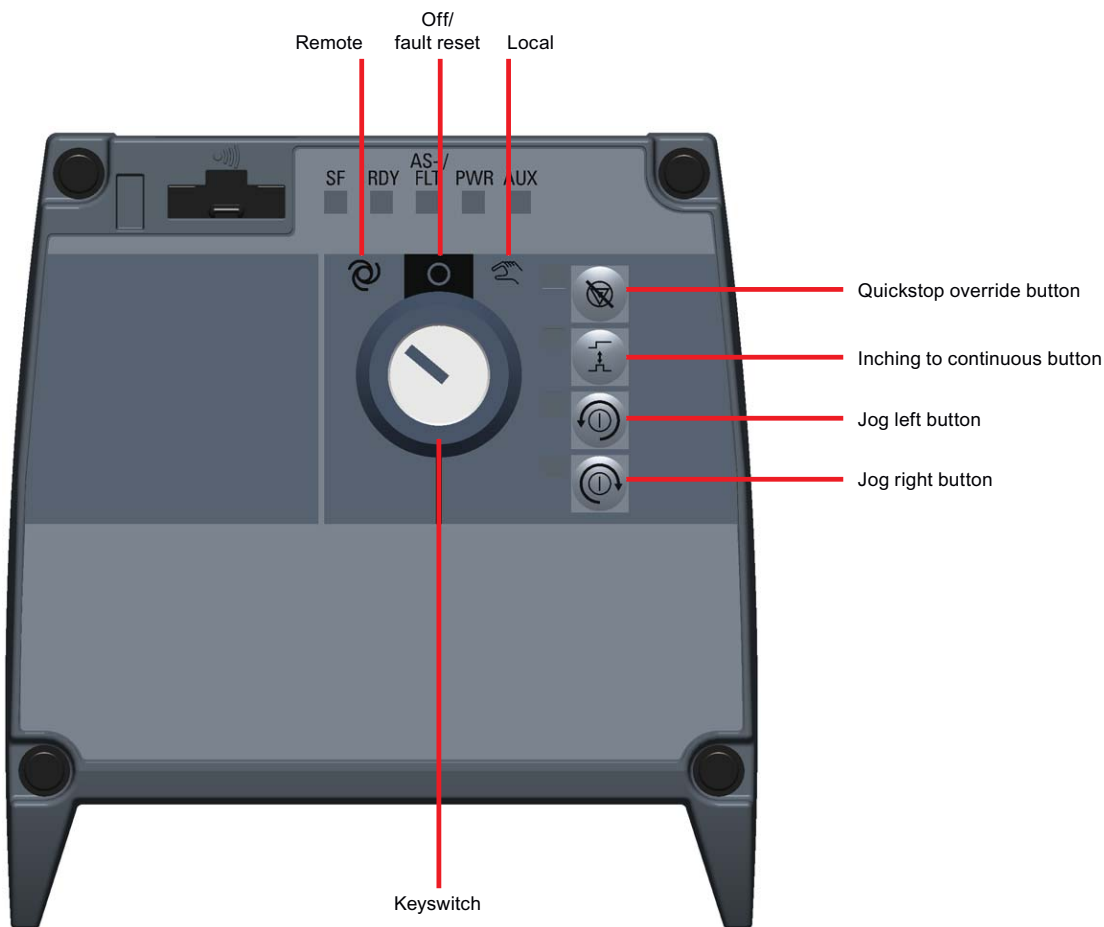

Figure 7-1 Local/remote switch cover layout

Functions

The functions of the various buttons and keyswitch positions are given in the table below.

Table 7- 1 Switch cover function description

Key/button	Description
Remote	In the remote position the Inverter will use the command source and setpoint source set in parameters P0700 and P1000 respectively. If the Inverter is part of an automated system, then it will be under the control of the PLC.
Off/fault reset	In this position the Inverter will be in standby with pulses disabled and will ignore any command source inputs. As the keyswitch is moved from this position a fault reset will occur.
Local	In this position the Inverter ignores the command source and setpoint source set in parameters P0700 and P1000 respectively. The Inverter will only react to the local buttons on the switch cover.
Quickstop override	The quickstop function enables the Inverter to react to sensors on a conveyor segment when items move passed the sensor. The quickstop override button, disables the Inverters reaction to the sensor signals.
Inching/continuous	This button toggles between inching and continuous movement of the motor. The movement of the motor is determined by the values set in Parameters P1058 and P1061. Inching: Press the Jog button to start the motor, and release the button to stop the motor. Continuous: Press the Jog button to start the motor, and press the Jog button again to stop the motor.
Jog left	Pressing the Jog left button will move the conveyor belt to the left.
Jog right	Pressing the Jog right button will move the conveyor belt to the right.

7.4 Repair switch

Overview

The Repair switch allows the motor to be totally isolated from the Inverter. This means that all power to the motor is terminated and the Inverter cannot start or stop the motor.

 WARNING
<p>Stopping the motor</p> <p>The motor must be stopped before activating the Repair switch. If the motor is not stopped the Inverter may be damaged.</p> <p>Discharge of Inverter</p> <p>Wait at least five minutes to allow the unit to discharge after switching the Repair switch off before carrying out any maintenance work.</p> <p>Electrical safety</p> <p>Regional installation and Safety Regulations regarding work on dangerous voltage installation (e.g. EN50178) as well as relevant regulations regarding the correct use of tools and personal equipment (PPE) still apply.</p>

The location of the Repair switch is shown in the figure below.

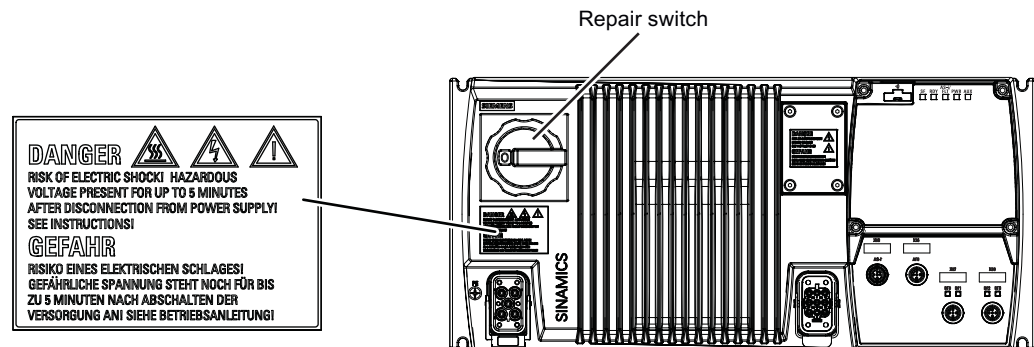

Figure 7-2 Repair switch

Function

When the Repair switch is set to OFF, all power to the motor is terminated. The Inverter pulses are disabled and the motor cannot be started or react in anyway to commands from the Inverter or the controlling PLC. With the mains are isolated fault F0003 will be generated.

The Repair switch can be padlocked into position so that once it has been switched off, it cannot be accidentally switched on.

The motor can be repaired or replaced as required. Once the Repair has been completed the Repair switch can be unlocked and switched on - the motor is then directly under the command of the Inverter or the controlling PLC.

It should be noted that although the motor is isolated, communications and commands can be passed between the controlling PLC and the Inverter, for example, parameters can be changed.

Messages and fault codes

8

8.1 Fault codes

Fault codes

The inverter has the capability to identify internal and external fault conditions, the most common faults are shown in the following tables. More detailed information on faults can be found in the Parameter List.

Table 8- 1 Fault codes description

Fault Number	Meaning	
F00001	Cause	Overcurrent - Motor power does not correspond to the inverter power
	Remedy	Check that the motor and inverter power ratings are the same.
F00002	Cause	Overvoltage - mains supply voltage too high or motor is in regenerative mode.
	Remedy	Check the mains supply voltage
F00003	Cause	Undervoltage - mains / 24 V supply has failed
	Remedy	Check mains supply / 24 V supply
F00004	Cause	Inverter over temperature - the inverter has exceeded the temperature limits
	Remedy	Check motor loading, pulse frequency setting, ambient temperature or if fitted the fan is working correctly.
F00030	Cause	Fan failure
	Remedy	Fan no longer working - replace fan.
F00041	Cause	Motor data identification failure
	Remedy	check that the motor is connected to the inverter correctly and that the motor data entered is correct.
F00062	Cause	MMC contents invalid
	Remedy	Recopy data to MMC and ensure that the process is completed.
F00070	Cause	PLC setpoint fault - the communications failure monitoring times, set by P2040 has expired.
	Remedy	Check: <ul style="list-style-type: none"> • If the AS-interface master has stopped or is in 'program' mode. • The cable connection between the bus nodes. • check if the communication monitoring time has been set too short in P2040.
F00071	Cause	USS setpoint fault - no setpoint values from USS during telegram off time.
	Remedy	Check and improve monitoring timing using STARTER

8.2 LED States

Fault Number	Meaning	
F00073	Cause	Control Panel setpoint fault - no setpoint values from Control Panel during telegram off time.
	Remedy	<ul style="list-style-type: none"> • Check and improve - if necessary - the value in P3984 • Acknowledge fault • If fault persists, contact Service Department or change Inverter.

8.2 LED States

LED description

The Inverter has five main LEDs which are used to indicate the state of the Inverter. Each digital input has its own status LED. These are shown in the figure below.

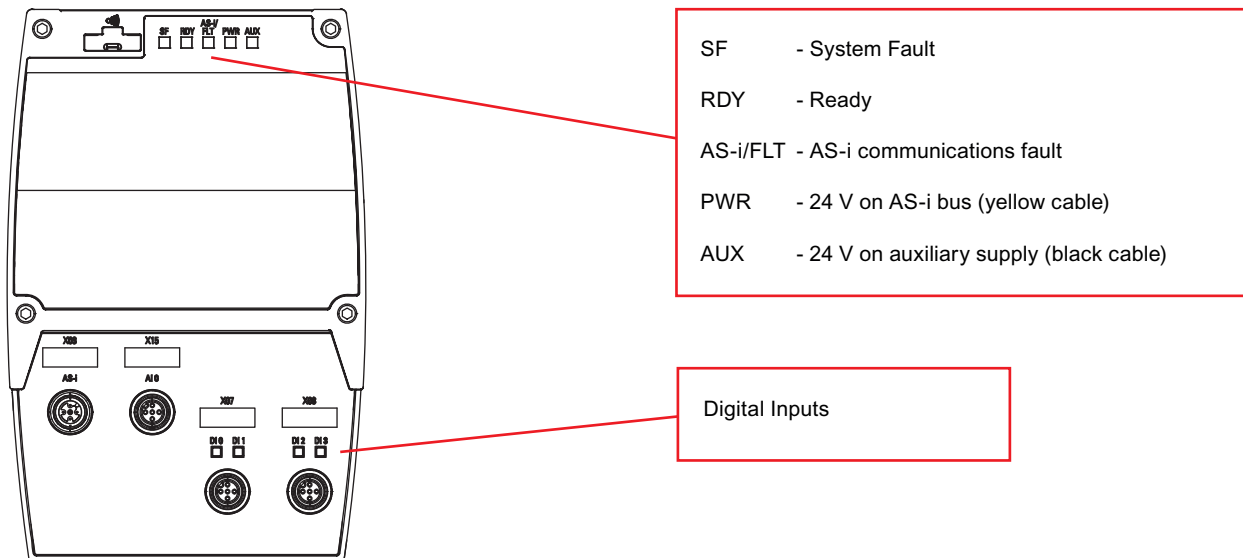

Figure 8-1 SINAMICS G110D LEDs

In the table below is shown all the possible states of the LEDs and their meaning.

Table 8- 2 SINAMICS G110D LED states

SF	RDY	AS-I/FLT	PWR	AUX	DI	Description
OFF	Flashing	-	-	-	-	Commissioning
Flashing	Flashing	-	-	-	-	Update from memory card or parameter download
ON	OFF	-	-	-	-	General fault
OFF	ON	-	-	-	-	Inverter ready or running
-	-	Flashing RED	-	-	-	No communications between processors within the Inverter
-	-	Flashing RED YELLOW	-	-	-	Slave address 0
-	-	Flashing GREEN RED	-	-	-	Inverter trip
-	-	RED	-	-	-	AS-i master not connected
-	-	GREEN	-	-	-	System OK
-	-	-	GREEN	-	-	Power OK
-	-	-	OFF	-	-	No power (yellow cable)
-	-	-	-	GREEN	-	Power OK
-	-	-	-	OFF	-	No power (black cable)
-	-	-	-	-	GREEN	Digital input active
-	-	-	-	-	OFF	No signal

Technical data

9.1 Technical data of the SINAMICS G110D

Technical data of the SINAMICS G110D

Feature	Data	
Line operating voltage	3 AC 380 V ... 500 V \pm 10%	The permissible line operating voltage depends on the installation altitude
Operating voltage	Supply from the ASi bus or an external 24 V DC supply (20.4 V to 28.8 V, 0.5 A)	
Input frequency	47 Hz ... 63 Hz	
Power factor λ	0.7 ... 0.85	
Overload capability	The SINAMICS G110D can either be operated with high overload (HO). In order to avoid overtemperature of the Power Module, after the overload, as a minimum its load must decrease back to the base load (HO base load or LO base load).	
	HO base load 0.75 kW ... 7.5 kW	150% overload for 57 s 200% overload for 3 s 87% HO base load for 240 s See note 1.
Digital inputs	4; PNP Low < 5 V, High > 10 V, maximum input voltage 30 V, 5.5 mA	
Analog inputs	1, with 10-bit resolution AI0: 0 V to 10 V, unipolar voltage only Analog input can also be configured as a digital input	
Setpoint resolution	0.01 Hz	
Pulse frequency	4 kHz for 0.75 kW ... 7.5 kW (HO)	
Possible braking methods	DC braking, dynamic braking with integrated braking chopper	
Degree of protection	IP65	
Operating temperature	0.75 kW ... 7.5 kW (HO) -10 °C ... +40 °C (14 °F ... 104 °F) See note 1.	Higher operating temperatures are possible when the rated power is reduced (derating)
Transport/storage temperature	-40 °C ... +70 °C (-40 °F ... 158 °F)	
Relative humidity	< 95% RH - condensation not permissible	
Installation altitude	0.75 kW ... 7.5 kW (HO) Up to 1000 m (3300 ft) above sea level	Higher altitudes are possible when the rated power is reduced (derating)

Technical data

9.1 Technical data of the SINAMICS G110D

Feature	Data
Dimensions (WxHxD)	FSA: 195 mm x 425 mm 125 mm (145 mm with repair switch) FSB: 195 mm x 425 mm 165 mm (165 mm with repair switch) FSC: 195 mm x 425 mm 240 mm (240 mm with repair switch)
Standards	UL, CE, C-tick In order that the system is UL-compliant, UL-certified fuses, overload circuit-breakers or branch circuit protection devices must be used
Note 1. Under nominal conditions	

Table 9- 1 Weight of SINAMICS G110 Inverters with repair switch

Order Number:	1PE17-5AM0	1PE21-5AM0	1PE23-0AM0	1PE24-0AM0	1PE25-5AM0	1PE27-5AM0
6SL3511-						
Power rating (kW)	0.75	1.5	3.0	4.0	5.5	7.5
Net weight (Kg)	7.0	7.0	7.2	7.7	9.7	9.8
Net weight (lbs)	15.4	15.4	15.9	17.0	21.4	21.6
Gross weight (Kg)	7.8	7.8	7.9	9.0	10.8	10.9
Gross weight (lbs)	17.2	17.2	17.4	19.8	23.8	24.0

Table 9- 2 Weight of SINAMICS G110 Inverters without repair switch

Order Number:	0PE17-5AM0	0PE21-5AM0	0PE23-0AM0	0PE24-0AM0	0PE25-5AM0	0PE27-5AM0
6SL3511-						
Power rating (kW)	0.75	1.5	3.0	4.0	5.5	7.5
Net weight (Kg)	6.7	6.7	6.9	7.4	9.4	9.5
Net weight (lbs)	14.8	14.8	15.2	16.3	20.7	20.9
Gross weight (Kg)	7.5	7.5	7.7	8.8	10.5	10.6
Gross weight (lbs)	16.5	16.5	17.0	19.4	23.1	23.4

9.2 Pulse frequency and current reduction

Pulse frequency and current reduction

Table 9- 3 Current reduction depending on pulse frequency

Power rating at 400 V	Frame size	Inverter current rating	Output current at pulse frequency of					
			at 4 kHz	6 kHz	8 kHz	10 kHz	12 kHz	14 kHz
kW		A	A	A	A	A	A	A
0.75	A	2.2	1.9	1.5	1.3	1.1	1.0	0.9
1.5	A	4.1	3.5	2.9	2.5	2.1	1.8	1.6
3	B	7.7	6.5	5.4	4.6	3.9	3.5	3.1
4	C	10.2	8.7	7.1	6.1	5.1	4.6	4.1
5.5	C	13.2	11.2	9.2	7.9	6.6	5.9	5.3
7.5	C	19	16.2	13.3	11.4	9.5	8.6	7.6

Appendix A

A.1 Electromagnetic compatibility

Electromagnetic compatibility

All manufacturers/assemblers of electrical apparatus which "performs a complete intrinsic function and is placed on the market as a single unit intended for the end user" must comply with the EMC directive EC/89/336.

There are three routes for the manufacturer/assembler to demonstrate compliance:

Self-certification

This is a manufacturer's declaration that the European standards applicable to the electrical environment for which the apparatus is intended have been met. Only standards that have been officially published in the Official Journal of the European Community can be cited in the manufacturer's declaration.

Technical construction file

A technical construction file can be prepared for the apparatus describing its EMC characteristics. This file must be approved by a 'Competent Body' appointed by the appropriate European government organization. This approach allows the use of standards that are still in preparation.

EMC Standards

The SINAMICS G110D Inverters have been tested in accordance with the EMC Product Standard EN 61800-3:2004.

A.1.1 Classification of EMC categories

Classification of EMC performance

The EMC environment and categories are defined within the EMC Product Standard EN 61800-3, as follows:

First Environment

An environment that includes domestic premises and establishments that are connected directly to a public low-voltage power supply network without the use of an intermediate transformer.

Note

For example: houses, apartments, commercial premises or offices in a residential building.

Second Environment

An environment that includes industrial premises and establishments that are not connected directly to a public low-voltage power supply network.

Note

For example: industrial and technical areas of buildings fed from a dedicated transformer.

- **Category C1**

Power Drive System (PDS) of rated voltage less than 1000 V intended for use in the First (Domestic) Environment.

- **Category C2**

Power Drive System (PDS) of rated voltage less than 1000 V, which is neither a plug in device nor a movable device, and when used in the First (Domestic) Environment, is only intended to be installed and commissioned by a professional.

Units installed within the Category C2 (Domestic) Environment require supply authority acceptance for connection to the public low-voltage power supply network. Please contact your local supply network provider.

Note

A professional is a person or an organization having the necessary skills in installing and/or commissioning a Power Drive System (PDS), including their EMC aspects.

- **Category C3**

Power Drive System (PDS) of rated voltage less than 1000 V intended for use in the Second (Industrial) Environment and not intended for use within the First (Domestic) Environment.

Table A- 1 Compliance Table

Model	Remarks
Category C1 - First Environment	
--	The SINAMICS G110D inverters are not intended for use within the Category C1 Environment.
Category C2 - First Environment - Professional Use	
Filtered Variants	Drives FSA ... FSB (400 V, 0.75 kW ... 7.5 kW)
6SL3525-0PE**-*A*0	Class A: 15 m screened cable type CY
	When used in the First (Domestic) Environment this product may cause radio interference in which case mitigation measures may be required.
Category C3 - Second Environment	
Unfiltered Variants	There are no unfiltered variants

Note

All drives should be installed and commissioned in accordance with the manufacturer's guidelines and in accordance with good EMC practices.

For further information refer to SIEMENS application note "EMC Design Guidelines".

A.1.2 EMC performance

EMC Emissions

The SINAMICS G110D inverters have been tested in accordance with the emission requirements of the category C2 (domestic) environment.

Table A- 2 Conducted & Radiated Emissions

EMC Phenomenon	Standard	Level
Conducted Emissions	EN 55011	Class A
Radiated Emissions	EN 55011	Class A

Note

To achieve this performance the default switching frequency should not be exceeded and the recommended cables and connectors should be fitted correctly.

Achieving radiated emissions to EN 55011 Class B is largely dependent on the inverter being correctly installed inside a metallic enclosure. The limits will not be met if the inverter is not enclosed or installed in accordance with good EMC practices.

Harmonic Currents

The harmonic current emissions from the SINAMICS G110 D inverters is as follows:

Table A- 3 Harmonic Currents

Rating	Typical Harmonic Current (% of rated input current)							
	5th	7th	11th	13th	17th	19th	23rd	25th
FSA ... FSC (400 V, 0.75 kW ... 7.5 kW)	73	52	25	23	22	15	12	10

Note

Units installed within the category C2 (domestic) environment require supply authority acceptance before connection to the public low-voltage power supply network. Please contact your local supply network provider.

Units installed within the category C3 (industrial) environment do not require connection approval.

EMC Immunity

The SINAMICS G110 D inverters have been tested in accordance with the immunity requirements of category C3 (industrial) environment:

Table A- 4 EMC Immunity

EMC Phenomenon	Standard	Level	Performance Criterion
Electrostatic Discharge (ESD)	EN 61000-4-2	4 kV Contact discharge	A
		8 kV Air discharge	
Radio-frequency Electromagnetic Field	EN 61000-4-3	80 MHz ... 1000 MHz 10 V/m	A
Amplitude modulated		80 % AM at 1 kHz	
Fast Transient Bursts	EN 61000-4-4	2 kV @ 5 kHz	A
Surge Voltage	EN 61000-4-5	1 kV differential (L-L)	A
1.2/50 μ s		2 kV common (L-E)	
Conducted	EN 61000-4-6	0.15 MHz ... 80 MHz 10 V/rms	A
Radio-frequency Common Mode		80 % AM at 1 kHz	
Mains Interruptions & Voltage Dips	EN 61000-4-11	100 % dip for 3 ms	C
		30 % dip for 10 ms	C
		60 % dip for 100 ms	C
		95 % dip for 5000 ms	C
Voltage Distortion	EN 61000-2-4 Class 3	10 % THD	A

EMC Phenomenon	Standard	Level	Performance Criterion
Voltage Unbalance	EN 61000-2-4 Class 3	3 % Negative Phase Sequence	A
Frequency Variation	EN 61000-2-4 Class 3	Nominal 50 Hz or 60 Hz (± 4 %)	A
Commutation Notches	EN 60146-1-1 Class B	Depth = 40 %	A
		Area = 250 % x degrees	

A.2 Standards



European Low Voltage Directive

The SINAMICS G110D product range complies with the requirements of the Low Voltage Directive 2006/95/EC. The units are certified for compliance with the following standards:

EN 61800-5-1 — Semiconductor inverters –General requirements and line commutated inverters
EN 60204-1 — Safety of machinery –Electrical equipment of machines

European Machinery Directive

The SINAMICS G110D inverter series does not fall under the scope of the Machinery Directive. However, the products have been fully evaluated for compliance with the essential Health & Safety requirements of the directive when used in a typical machine application. A Declaration of Incorporation is available on request.

European EMC Directive

When installed according to the recommendations described in this manual, the SINAMICS G110D fulfils all requirements of the EMC Directive as defined by the EMC Product Standard for Power Drive Systems EN 61800-3



Underwriters Laboratories

UL LISTED POWER CONVERSION EQUIPMENT for use in a pollution degree 2 environment.

ISO 9001

Siemens plc operates a quality management system, which complies with the requirements of ISO 9001.

Certificates can be downloaded from the internet under the following link:
(<http://support.automation.siemens.com/WW/view/en/22339653/134200>)

Index

A

- Adapter Plate, 36
- Address cable, 51
- Addressing, 157
- Addressing by parameter, 158
- Addressing the AS-i device, 53
- Adjustable parameters, 22
- Altitude, 42
- Ambient temperature, 62
- analog input, 103
- Analog input specifications, 49
- Analog inputs, 193
- AS-i address programmer, 51
- AS-i connection kit, 51
- AS-i connector specifications, 49
- AS-i Master, 53
- AS-i network, 147
- AS-i slave identities, 155, 157
- AS-Interface, 145
- Atmospheric pollution, 43
- Auto addressing, 158
- Automatic mode, 107
- Automatic restart, 131, 132, 133

B

- Basic commissioning, 66
- BICO parameters, 27
- BICO technology, 26
- Binectors, 26
- Block diagram, 46
- Blocking protection, 120
- Boost parameter, 111
- Brake voltage, 44
- Braking methods, 122
- Braking resistor, 125
- Braking resistors, 36
- Break loose torque, 25

C

- Cable connection, 17
- Cable lengths, 44
- CDS, 107
- Classification of EMC performance, 197

- command and setpoint sources, 64
- Command Data Set, 107
- Command data set switchover, 107
- command source, 100
- Command source, 63, 90
 - Selecting, 24
- commissioning options, 59
- Commissioning situations, 59
- Commissioning the application, 75, 81
- Compound braking, 123
- Configuring AS-i slaves, 153
- Configuring the AS-i master, 151
- Connection specifications, 48
- Connections and cables, 44
- Connectors, 26
- Control commands, 91
- Control Data Set, CDS, 107
- Control mode, 62
- Control Unit connectors, 47
- Controlling the motor, 91
- CTT2 Error Codes, 166
- Current input, 103
- Current reduction, 195
- Cyclic Data Transfer, 167

D

- Data backup, 59, 86
- Data transfer, 86
- DC braking, 123, 124
- DC link voltage, 119
- Degree of protection, 193
- Digital input specifications, 49
- digital inputs, 101
- Digital inputs, 193
 - Settings for the, 101
- Dimensions, 194
- Direction reversal, 91
- Display parameters, 22
- Down ramp, 25
- Download, 86
- Drill pattern, 40
- Drive Data Set, DDS, 139
- Drive Data Sets, 139
- Dynamic braking, 123, 125

E

- earth leakage, 15
- ELCB, 15
- Electromagnetic compatibility, 197
- Electromagnetic radiation, 43
- EM brake, 48
- EMC Emissions, 199
- EMC Immunity, 200
- EMC Standards, 197
- Energy recovery option, 119
- Enter clockwise or counter-clockwise rotation of the motor, 91
- Error Responses, 172
- European EMC Directive, 201
- European Low Voltage Directive, 201
- European Machinery Directive, 201
- Extender, 147
- Extension plug, 147

F

- Factory setting
 - Control commands, 91
- factory settings
 - Restoring the, 60
- FCC
 - Flux Current Control, 114
- Firmware version, 24
- fixed frequency, 104
- Flow control, 138
- Flying restart, 135, 136, 137
- Follow-on parameterization, 23
- Force the brake open, 131
- Function blocks
 - Unassigned, 138, 139
- functions
 - Technological, 90
- Functions
 - Overview, 89
- Fuses, 43

G

- General layout, 38
- Group fusing, 43

H

- Harmonic Currents, 200
- Humidity range, 42

I

- I_{max} controller, 117
- Inching/continuous, 186
- IND components, 165
- Input frequency, 193
- Installation altitude, 193
- Installation procedure, 37
- Installing and commissioning the CP343-2, 149
- Integrating the Inverter in a AS-i master, 149
- Intelligent Operator Panel (IOP), 76
- Interfaces, 59
- Inverter control, 90
- Inverter functions, 89
- IOP controls, 78
- IOP Handheld Kit, 79
- IOP Hand-held Kit, 34
- ISO 9001, 201

J

- JOG function, 105
- Jog mode, 105

K

- Keypad, 34
- KTY 84 temperature sensor, 117

L

- LED states, 191
- Level control, 138
- Load capacity, 149
- local/remote switch cover, 185
- Locking and unlocking the keypad, 78

M

- Mains supply connector, 47
- Manual mode, 107
- Maximum current controller, 117
- Maximum frequency, 25, 63, 109
- Memory Card, 35
- Memory card reader, 35
- Minimum frequency, 25, 63, 109
- MMC, 59, 86
- MMC memory card, 59, 86
- mobile radio devices, 15
- MOP, 103
- Motor connector, 48

Motor data, 61
 Motor holding brake, 128, 129, 131
 Motor rating plate, 61
 Motor temperature sensor, 117
 Motorized potentiometer, 103
 mounting orientation, 41

N

network structure, 52
 No-load monitoring, 120

O

Operating parameters, 152
 Operating temperature, 193
 Operating voltage, 193
 Operator Panel, 59
 Optical cable, 80
 Overload, 25, 118
 Overload capability, 193
 Overvoltage, 119

P

Parameter assignment, 22
 Parameter types, 22
 PC connection cable, 66
 PC-Inverter connection kit, 36
 PELV, 15
 PID controller, 138
 PKW error codes, 164
 PKW mechanism, 162
 PLC functionality, 28
 Power factor, 193
 Power failure, 131
 Pressure control, 138
 Profile 3.0, 50
 Programmable process images, 160
 Protection functions, 90
 PTC temperature sensor, 117
 Pulse frequency, 193, 195
 PWE components, 165

Q

Quick Stop function, 141
 Quickstop override, 186

R

Ramp-down time, 25, 63, 110
 Rampup time, 25, 63, 110
 RCCB, 15
 RCD, 15
 Recommended AS-i connector, 147
 Regenerative energy, 122
 Relative humidity, 193
 Remote, 186
 Repair switch, 186
 Repeater, 147
 Replacing the Inverter, 183
 Restoring factory settings, 60
 Rounding, 110

S

Safety notes
 Commissioning, 17
 Dismantling and disposal, 18
 General Warnings, Cautions and Notices, 15
 Operation, 18
 Repair, 18
 Transport and storage, 17
 Saving parameter data, 75
 Saving the parameters on the IOP, 85
 Scaling, 103
 SD Manual Collection, 21
 Seals fitted correctly, 39
 Selecting the setpoint source, 25
 Self certification, 197
 SELV, 15
 Serial data transfer, 166
 Setpoint calculation, 90, 109
 Setpoint resolution, 193
 setpoint source, 102
 Setpoint source, 63, 90
 Setting the slave address of the Inverter, 150
 Shock and vibration, 42
 Signal interconnection, 26, 29
 Spare parts, 36
 specifications, 43
 Stall protection, 120
 Standard Acyclic Data Transfer, 168
 Standards, 201
 STARTER, 59
 Starting characteristics
 Optimizing the, 111
 Static discharges, 15
 Switches and contactors, 44

T

- Technical construction file, 197
- Technical data, 193
- Temperature, 42
- Temperature monitoring, 115, 116
- Temperature sensor, 44, 48
- ThermoClick temperature sensor, 117
- Three-wire control, 91, 93
- TN and TT mains supplies, 39
- Tools, 47
- Torque monitoring
 - Frequency-dependent, 120
- Two-wire control, 91, 92

U

- Underwriters Laboratories, 201
- Up ramp, 25
- Upload, 87

V

- V/f control, 113
- Vendor Specific Acyclic Data Transfer, 168
- Voltage boost, 111, 112
- Voltage input, 103

W

- Water, 43

Siemens AG
Industry Sector
Postfach 48 48
90026 NÜRNBERG
DEUTSCHLAND

Änderungen vorbehalten
E86060-KXXXX-AXXX-AX(-XXXX)
© Siemens AG 2009

www.siemens.com/automation